

FLAME MONITORING SYSTEM

MODEL 700 / 800 SIGNAL PROCESSOR AND VIEWING HEAD APPLICATION MANUAL



TABLE OF CONTENTS

GENERAL DESCRIPTION 4

IR DETECTOR 5

UV DETECTOR 5

SELF-CHECKING 5

INTERNAL PARAMETER STORAGE 5

MODEL 700 POWER CONNECTIONS 6

VIEWING HEAD CONNECTOR AND WIRING 6

PROTECTING THE VIEWING HEAD CABLE 7

GREEN AND RED LED INDICATORS 7

VIEWING HEAD MOUNTING BLOCK 7

SETTING THE VIEWING HEAD GAIN 7

ADJUSTMENT OF VH SIGHTING AND GAIN 8

ORIFICING 8

MANUAL SETUP OF SET POINTS – MODELS 700 & 800 8

AUTOMATIC SETUP – MODEL 700 ONLY 9

FILTER SELECTION FOR IR VIEWING HEAD 10

LOADING FACTORY DEFAULTS 10

SETTING FFRT – MODELS 700 AND 800 11

0-20 MA/4-20 MA OPTION – MODELS 700 & 800 11

LOCKOUT OR FAULTY VH INDICATION 11

PANEL LOCK 11

PANEL LOCK WITH NO VH CONNECTED 11

WORKING WITH OLDER UV VIEWING HEADS 11

MODEL 700 COMMUNICATIONS 12

MODEL 800 COMMUNICATIONS 12

APPROVALS 12

CONTACT INFORMATION 12

FIGURES 1-16 AND FLOW CHARTS 1-9 13-33

SPECIFICATIONS FOR SERIES 700 AND 800 VIEWING HEADS 34

SPECIFICATIONS FOR MODEL 700AC & MODEL 700DC SIGNAL
PROCESSORS 35

SPECIFICATIONS FOR MODEL 800 SIGNAL PROCESSOR 35

FIGURE AND FLOW CHART INDEX

FIGURE 1 - MODEL 700AC SIGNAL PROCESSOR 13

FIGURE 2 - MODEL 700AC SIGNAL PROCESSOR WIRING 14

FIGURE 3 - MODEL 700DC SIGNAL PROCESSOR 15

FIGURE 4 - MODEL 700DC SIGNAL PROCESSOR WIRING 16

FIGURE 5 - MODEL 800 SIGNAL PROCESSOR ON DIN RAIL 17

FIGURE 6 - MODEL 800 SIGNAL PROCESSOR WIRING 17

FIGURE 7 - MODEL S702 AND S706 VIEWING HEADS 18

FIGURE 8 - MODEL S802 AND S806 VIEWING HEADS 19

FIGURE 9 - MOLDED CONNECTOR AND CONNECTOR CLIP 20

FIGURE 10 - VIEWING HEAD CABLE AND WIRING 20

FIGURE 11 - MODEL 700 VIEWING HEAD CABLE WITH 1/2" NPT FITTING 21

FIGURE 12 - MODEL 700/800 VIEWING HEAD CABLE FIELD MAKE UP WIRING .. 21

FIGURE 13 - WIRING OF RS-422 TO RS-232 CONVERTER TO MODEL 700 SIGNAL
PROCESSOR 22

FIGURE 14 - COMMUNICATIONS CABLE FOR MODEL 800 SP 23

FIGURE 15 - MODEL 700/800 PROGRAMMER AND 800 CABLE 24

FLOW CHART 1 - SETTING FACTORY DEFAULTS 25

FLOW CHART 2 - AUTO SETUP PAGE 1 26

FLOW CHART 3 - AUTO SETUP PAGE 2 27

FLOW CHART 4 - AUTO SETUP PAGE 3 28

FLOW CHART 5 - MANUAL FLAME ON SETUP 29

FLOW CHART 6 - MANUAL FLAME OFF SETUP 30

FLOW CHART 7 - FLAME FAILURE RESPONSE TIME (FFRT) SETUP 31

FLOW CHART 8 - 0-20/4-20MA ANALOG OUTPUT SETUP 32

FLOW CHART 9 - VIEWING HEAD GAIN SETTING 33

GENERAL DESCRIPTION

Model 700AC, Model 700DC and Model 800 are single-channel, fail-safe, flame monitoring systems. They offer easy setup, excellent discrimination, and high reliability.

Components are interchangeable between the 700 and 800 families. Any viewing head in the two families will work with any of the signal processors.

Three signal processor models are available:

Model 700AC	Universal AC powered
Model 700DC	24VDC powered
Model 800	Universal AC powered

The two Model 700 signal processors are very similar, with 12 push-buttons, a two-digit numeric display, and four LED status indicators to communicate with the operator. The only difference between the two is that one accepts AC power and the other accepts DC power. Most of the signal processor connections are made through high quality, Phoenix plug-in connectors. Communications connections are made through modular phone jacks at the top of the signal processors (Figures 1 - 4).

The Model 800 signal processor is quite small (Figure 5), having only one push-button and two LED indicators. Setup is achieved by using a computer running the supplied application software, or with the programmer and cable, available separately. An RS-232 communications cable, also available separately, is connected from the computer to the input labelled PROGRAM on the front of the Model 800. Using the software, you can set gains, adjust set points, and perform other setup and monitoring functions. The other signal processor connections to the Model 800 are made through 12 Phoenix screw terminals. (Figure 6)

All three signal processor models mount on a standard 35 mm DIN rail. They snap into place and may be released from the rail using a flat screwdriver.

There are basically two types of viewing heads -IR/flicker-sensitive and UV-sensitive- but the various features offered result in nine different models due to packaging variations.

The S702 and S706 viewing head housings are larger in diameter, are made of aluminum, and are secured with over-center latches to their mounting blocks (Figure 7). In contrast, the S802 and S806 viewing head housings are smaller in diameter and are made of stainless steel (Figure 8). An 800 series viewing head is secured in its mounting block by a friction twist-lock simi-

lar to those used to lock the legs of camera tripods.

The IR/flicker sensitive viewing heads have a high pass-filter that passes flicker frequencies above 33 Hz, but an alternative high-frequency filter that passes only frequencies above 155 Hz is available. These models are identified by adding “-HF” to the model number. The UV models respond to the absolute level of UV radiation - not UV flicker - so there is no filter option.

The standard connector supplied with both the 700 and 800 viewing head models has two indicator LEDs inside it: the green one to indicate signal pulses (helpful in alignment), and an orange one to indicate activity on the self-check line (Figure 12). The green LED also flashes once per second when the orange LED is pulsed as the viewing head sends an ID code back to the signal processor. Figures 9 and 10 show, for reference, a molded connector with cable which has been discontinued. Model 700 viewing heads are also available with a 1/2” pipe fitting for connecting to electrical conduits. The four connecting wires exit through an epoxy seal in the 1/2” pipe fitting (Figure 11). The LED indicators are not present in the pipe-fitting option.

The available models are as follows:

S702	Basic IR/flicker model
S702-HF	IR/flicker with high frequency filter
S702-PF	IR/flicker with pipe fitting
S702-HF-PF	IR/flicker with HF filter & pipe fitting
S706	Basic UV model
S706-PF	UV with pipe fitting
S802	Basic IR/flicker model
S802-HF	IR/flicker with high frequency filter
S806	Basic UV model

The viewing heads, the viewing head connector, and the cable provided are watertight, and have NEMA 4 and 4X ratings when the connector is tightened with pliers and the cable is protected from UV.

The availability of both UV-sensing and IR/flicker-sensing viewing heads ensures that the Model 700 and Model 800 flame monitoring systems can provide good discrimination in virtually any application. UV sensing is appropriate for monitoring the burning of light oil and especially for the burning of natural gas. IR/flicker sensing is appropriate for monitoring heavy oil and coal flames.

IR DETECTOR

The models S702 and S802 viewing heads use the same InGaAs (Indium Gallium Arsenide) photodiode used in our S511, S550, and S552 viewing head models. This IR photodiode responds to IR in the 950nm to 1710nm range (1/2 intensity points). The use of IR flicker instead of IR intensity in the viewing head has many advantages - one being that the viewing head does not respond to glowing refractory in the furnace. The main advantage comes from the fact that high frequency flicker is produced in the turbulent part of the burner flame, close to the root where combustion takes place. When this part of the flame is monitored, and when the viewing head responds only to the high frequency flicker, the turbulent part of the flame stands out from bright, but less turbulent, portions of other flames. The standard S702, S702-PF and S802 viewing heads respond to flicker frequencies above 33 Hz; the S702-HF, S702-HF-PF and the S802-HF viewing heads respond to flicker frequencies above 155 Hz.

UV DETECTOR

The S706, S706-PF and S806 viewing heads use the same UVtron tube for UV sensing that we have been using on our other UV-sensitive viewing heads. The UVtron responds only to short wavelength ultraviolet radiation in the 185-260nm range. This radiation is a direct result of the combustion process as oxygen combines with hydrocarbons in the fuel in the blue part of the flame. The yellow part of flames, and the background radiation from tubes or firebrick, do not emit UV radiation. So, where viewing heads can be aimed at the root of burner flames, UV monitoring provides excellent discrimination between flames in adjacent burners in multiburner applications.

SELF-CHECKING

There is a small processor in both the IR and UV viewing heads, so it is possible that this processor could fail and produce erroneous viewing-head pulses. The self-check circuitry guards against this. There are several tasks that require intelligent interaction between the viewing heads and the signal processor. If all of these interactions do not occur properly, the viewing head will not send pulses back to the signal processor and the flame relay will open.

Verifying the validity of the gain code received is one of the tasks performed by the processor in the IR and in the UV viewing heads. The self-check pulse from the signal processors is a 100ms-wide, 20V to 24V pulse with two "notches" or breaks in it. The position of each of the two notches communicates a gain code of one to nine plus

parity to the viewing head. The viewing head sends back an ID pulse in the first half of the 100ms self-check time. One viewing head expects to receive data with one parity and the other expects to receive data with the other parity. If a viewing head does not receive its correct parity plus the gain code once per second, it produces no output pulses.

There is also intelligent interaction between the older S706 viewing heads, which did not have the gain-change feature from the signal processor. The processor in the S706 viewing head monitors the 100ms width of the self-check pulse coming from the signal processor. If the pulse is not the correct width the viewing head produces no output pulses. Also, if the signal processor receives any pulses back from the viewing head during the last half of the 100ms self-check time, it assumes that a processor failure has occurred in the viewing head, opens both relays, and displays "LO" (lockout).

INTERNAL PARAMETER STORAGE

Set point values and other parameters plus error-checking codes are stored in EEPROM (Electrically Erasable Programmable Read Only Memory) in both the Model 700 and Model 800 signal processors. This data is then error-checked when it is read at power up. For the Model 700AC and Model 700DC, if the data does not match exactly what was stored, the signal processor discards all data, displays "EE", and loads factory defaults. The RELAY ON SET POINT is set to 31. Since the display cannot go this high, the flame relay cannot be energized. The signal processor can be reset by changing the RELAY ON SET POINT to a reasonable value or by pressing LOAD FACTORY DEFAULTS. For the Model 800, an internal EEPROM failure is indicated by a rapidly blinking green LED. Pressing the RESET button will clear the rapidly blinking LED but the Relay-on set point will remain set at 31. The Relay-on set point can only be changed by connecting a programmer or computer to the model 800 signal processor and loading factory defaults, or changing the relay on set point of 31 to a reasonable value. In any event, one should be suspicious of a signal processor that has failed in this way.

Note that information about the type of viewing head which was last used is also stored in EEPROM. If a Model 700 signal processor is powered up with a different type of viewing head, the signal processor discards the previous set-point data and loads factory defaults, except the RELAY ON SET POINT

is set to 31. To enable the Flame Relay to energize, change this set point to a reasonable value, or press **LOAD FACTORY DEFAULTS**. If a Model 800 signal processor is powered up with a different type of viewing head, the green LED will blink rapidly. The **RESET** button will clear the rapid blinking. Connect a programmer or a computer and change the **RELAY ON SET POINT** from 31 to a reasonable value.

MODEL 700 POWER CONNECTIONS

The Model 700AC power and relay connections are shown in Figure 2. The AC power supply in the Model 700AC Signal Processor is connected to input AC power through a 2A fuse and an inrush current limiter.

Model 700DC power and relay connections are shown in Figure 4. The nameplate current rating of 250mA maximum per signal processor with the viewing head plugged in is conservative; there is no need to install more power supply capacity than this.

In the Model 700 signal processors the flame relay (RF) has two sets of FORM C (SPDT) contacts and the self-check relay (SC) has one set (Figures 2 and 4). These power contacts are all rated at 5A at 125 VAC, 277 VAC, or 30 VDC. The self-check relay is on whenever the signal processor is on and is operating normally, whether the flame relay is energized or not. It is not necessary to wire the contacts of the self-check relay in series with the contacts of the flame relay because the actuating coil of the flame relay is wired in series with other contacts of the self-check relay (not shown). So the flame relay can only pull in if the self-check relay already has.

In the Model 800 signal processor the flame relay has two FORM A (SPST) contacts brought out to three terminals and one FORM A (SPST) contact brought out to two terminals (Figure 6). The flame relay is rated 5A at 125 VAC, 277 VAC or 30 VDC. The Self-Checking relay has one set of FORM A (SPST-NO) contacts rated .4A at 110 VDC or 125 VAC and 2A at 30 VDC.

In all Model 700 and 800 signal processors, special fail-safe circuitry is used to drive the coils of the self-check relay and the flame relay. This circuitry is designed so that any component failure will cause the flame relay to open. Also note that if the processor output which drives this circuitry sticks high or low, both relays will open.

Some of the internal power wiring of the Model 700AC and Model 700DC signal processors is shown in Figures 2 and 4. Rectifier diodes separate the battery backup input from the main power bus until the battery voltage exceeds the internal DC voltage plus a diode voltage drop. Resettable fuses (shown as resistors with slashes) and conventional fuses prevent internal failures from loading the power sources. With the Model 700DC, if a backup battery is to be used with a main power supply, the two power sources would be wired as shown in Figure 4. If no backup battery is to be installed, the main power supply can be connected at +26V PWR and GND as shown in Figure 4, or it can be connected to the +24V BATT input and GND. It is preferable, in fact, to use the battery connections because this takes advantage of the resettable fuse at the battery input. (Resettable fuses recover automatically from a fault within a few seconds after power is removed.) At the +26V PWR input and its associated GND, conventional 1A fuses are used because they are able to protect against 240VAC being applied by accident (this could happen if a Model 700DC is installed in a cabinet wired for a Model 700AC).

VIEWING HEAD CONNECTOR AND WIRING

Connectors and cables are shown in Figures 9 through 12. The molded connector, cable, and adapter shown in Figures 9 and 10 have been discontinued in favor of a cable with a shield. (They are shown for reference only.) Figure 11 shows the viewing head cable with the ½" NPT pipe fitting for use in a conduit. This gray cable is labeled: **LAPP USA UNITRONIC 190CY B (UL) TYPE CMG 105C 22AWG/4C SHIELDED E130334 -- CSA CMG 105C or AWM II A/B 300V LL74246**. The standard pigtail length is 20", but it can be supplied in longer lengths if requested. This same gray cable is shown in Figure 12 for regular viewing head service. Because it must be used with a conduit in hazardous locations, it is not normally supplied except when requested. It may be ordered commercially as Olflex 602204S.

The recommended cable for hazardous locations, C-330, is shown in the lower part of Figure 12 with the right-angle connector. It is supplied as standard in a 15 ft. length. This cable does not have to be used in a conduit. It is labeled: **C330 E193849 (UL) TYPE ITC 4/C 18 AWG 90C 300V OR c(UL) CIC 90C 600V FT4 SUNLIGHT RESISTANT**. If a cable longer than 15 ft. is needed,

custom cable lengths up to 4000 ft. may be ordered. This cable C330 is available in lengths of 552/zzz'lp'GW.

The customer may also supply his own cable; you will supply the mating viewing head connector along with the LED indicator assembly which goes inside the connector. The use of shielded cable is recommended, either an overall shield or a cable with a shield for the signal line. The shield should be connected to GND at the processor end and to the ground wire at the viewing head end. The cable diameter should not exceed .307" in order for it to go through the hex bushing in the connector. But note that wiring the cable to the connector is not easy because of the limited space. Also, the LED indicator assembly must be mounted inside the connector and, preferably, soldered in place.

NOTE: FOR CLASS I, DIV 2 RATING, CABLING IN HAZARDOUS LOCATIONS MUST COMPLY WITH NEC ARTICLE 500 REQUIREMENTS.

In particular, in the US, cables should have UL's ITC rating; in Canada, cables should have CSA's CIC rating. The recommended C-330 cable has both ratings.

Note: To obtain a NEMA 4X seal between the connector and the viewing head, tighten the metal connector ring securely using a pair of pliers.

PROTECTING THE VIEWING HEAD CABLE

It is usually desirable to mechanically protect the cable going to the viewing head. Flexible conduit and adapters can be supplied for this purpose. See Figure 12. The 700 LTA (Liquatite Adapter) is a custom connector/drg'r ctv; it screws into the right-angle connector in place of the standard hex bushing. Con74 is a Thomas and Betts TAB5330 Liquatite Fitting which is designed to give a watertight seal for Cdt02 Flexible Liquatite Conduit, part number LT-516 by Electra-Flex. These components have internal dimensions to clear a 5/16" diameter cable. For each viewing head a 700 LTA, a Cdt02 flexible conduit, and two Con74s will be needed. The 700 LTA, Con74 and Cdt02 can be purchased commercially. The customer can fit the Liquatite flexible conduit over the cable supplied with the viewing head by first unscrewing the hex bushing from the connector and removing it from the cable and then sliding the 700 LTA, Con74 and Cdt02 assembly over the cable and screwing the assembly into the right-angle connector. The Cdt02 flexible conduit is terminated with the second Con74 Liquatite fitting which ends with a 3/8"

NPT thread. Note that when the wiring needs to meet Class I, Division 2 requirements for use in hazardous locations and when conduit is used, the conduit must be sealed where the cable passes from the hazardous location to the non-hazardous location in order to keep potentially hazardous gases from being conducted into the non-hazardous area.

GREEN AND ORANGE LED INDICATIONS

The connector has orange and green LEDs which can be viewed from the rear of the connector. The green LED displays the pulses out of the viewing head and an orange LED shows that the self-checking signal from the signal processor is reaching the viewing head. If power is on at the signal processor, the orange LED should flash at one pulse per second, even if the viewing head is not plugged in. This is helpful in trouble-shooting. With no flame signal present, the green LED will flash one pulse per second in step with the self-checking signal. The viewing head is sending back an ID pulse; this is part of the self-checking system. When a flame is present, the green LED will blink at a rate proportional to the flame signal, except that the pulses are interrupted once per second when the self-check pulse arrives at the viewing head. The pulse rate of the green LED flashes can be used for aiming the viewing head.

VIEWING HEAD MOUNTING BLOCK

The viewing head is held firmly in place in its mounting block by two galvanized steel latches. The mounting block is made from a hard Delrin rated for continuous service to 82°C (180°F). An alternative mounting block made from Ultem 1000 is available, rated for continuous service up to 160°C (320°F).

Both mounting blocks have a 1/4-18 NPT female thread for a purge air connection. While it is true that the viewing head is rated for operation to 85°C (185°F), this temperature is still much lower than the temperature in a boiler or furnace, so continuous purge air must be provided.

SETTING THE VIEWING HEAD GAIN

The gain of the new intelligent IR and UV viewing heads can be adjusted. At power-up, Model 700 signal processors display codes to tell the operator what type of viewing head and what gain is being used. Typical displays are "r7" for the IR VH, "u3" for the UV VH and "U5" for an older UV viewing head. The numeric digit indicates gain. For the intelligent UV and IR viewing heads, the gain can be adjusted from 1 to 9 with a gain of 5 being the factory default gain. To change the gain, press

the button labeled SET GAIN for two seconds and use the INCREASE and DECREASE buttons. The gain is live; changes are effective immediately, but if the displayed gain value is not stored (by pressing STORE), and no other buttons are pressed, the processor returns to the previous setting after four seconds. The older UV viewing head always has a gain of 5, so “U5” is always displayed. When an older UV viewing head is plugged in, there is no response to a two second press of the SET GAIN button.

The gain steps have a ratio of 1:1.19. Going from a gain of 5 to a gain of 9 doubles the gain; going from a gain of 5 to a gain of 1 halves the gain.

If you have a Model 800 signal processor, then with a programmer or a computer running the appropriate software, the same functions as above are available, except that “r7”, “u3” or “U5” are not displayed at power up.

ADJUSTMENT OF VH SIGHTING AND GAIN

The viewing head should be properly sighted in before the set points are adjusted. Adjustment can be made easier by a 1/2” swivel joint, which is not available. While the burner is firing, vary the viewing angle while observing the green LED on the connector at the rear of the viewing head. Adjust the viewing angle for the maximum pulse rate, then lock the swivel joint to preserve this mechanical setting. If the LED pulse rate is very high or very low, see the two paragraphs below. The locked mechanical setting should still be correct when Model 700 viewing heads are interchanged, because inside each Model 700 viewing head the optical axis is aligned with the mechanical axis within $\pm 1/4$ degree. Also, the reading shouldn't change when a viewing head is rotated in the mount.

For the above sighting adjustments to work properly, the blinking rate of the green LED in the connector at the rear of the viewing head must be reasonable. If the displayed count is above 25, the pulses begin to blur together, making changes in the pulse rate difficult to observe. If the count is higher (29 or 30), then the viewing head is in saturation. Saturation means that the count would like to be even higher, possibly 50 or more, but it is internally clamped. With count rates in saturation or close to saturation, an operator will not be able to “wobble” the viewing head in the swivel mount and maximize the count rate properly. It should be possible to bring high count rates down to a useable level by decreasing the gain. If the gain is set to 1 and the count is still 25 or higher, orificing is needed. See the section on orificing below.

If the displayed count is less than 8 or 10, it will be difficult to maximize the count by aiming the viewing head, because the pulses come through too infrequently. In this case the gain should be increased. A count rate of around 16 to 20 is recommended. If the gain is set to a maximum and the count rate is still down around 5 or 6, the system can still be made to work reliably as long as the count rate drops significantly when the flame is removed. Nevertheless, you should question the setup. Is the viewing head aimed properly? Is it seeing flame directly?

ORIFICING

If the displayed count is 25 or higher when the gain is set to 1, an orificing disc inserted in the back end of the mounting block is recommended. An orifice kit is available as an inexpensive accessory from J qpg{y gm part number M-702-6s, for Model 700 and Model 800 viewing heads. Each kit contains a selection of orifice discs and a snap ring to hold the selected disc in place. Try to choose a disc that gives a reading of 12 to 24 at a low fire firing rate. The discs have a range of orifice sizes; each size step results in about a 2:1 change in the counts displayed.

MANUAL SETUP OF SET POINTS – MODELS 700 & 800

The keypad of the Model 700 signal processor is used to set the RELAY ON and RELAY OFF set points. The following section describes this process. The following section applies to the Model 800 signal processor as well because it works like the Model 700 signal processor.

To change the RELAY ON and RELAY OFF set points, the keypad functions are still needed. These functions are achieved using RS-232 serial communications through the stereo phone jack on the front of the Model 800. You can use a remote keypad in one of two ways:

- 1) By using a setup programmer available from J qpg{y gm This programmer looks and works like the keypad on a Model 700 signal processor. (Figure 15). A special cable is supplied with the programmer.
- 2) By connecting the Model 800 signal processor to a computer. The supplied software graphically simulates a keypad for the Model 800 on the computer screen. Another special cable is available to connect between the stereo phone jack of the Model 800 and a male DB9 (9 pin) serial port connector on the computer (Figure 13).

A desktop or notebook computer may be used. Both remote keypad approaches permit the set points to be adjusted, but they differ slightly in some details from the actual Model 700 keypad. For example, neither of the two approaches shows the keys for automatic setup, because the Model 800 does not support this feature.

Once the addresses of Model 800s have been set to different values, up to 32 Model 800s can be interconnected on the same RS-232 bus in a multi-drop hookup. The programmer could be mounted nearby and permanently connected to the same RS-232 bus; it can then easily address any of the Model 800s (using the DEVICE SELECT key) and check each units settings.

For more specific information on setting up the Model 800 signal processor by using a computer to simulate the keypad, install the Model 800 Setup software on the computer, plug the special RS-232 cable both into the computer and the Model 800, and run the software.

Changing the set points for the Model 700 and 800 signal processors is straightforward. The two numeric digits on the Model 700 signal processor (or the equivalent on the remote display for the Model 800) normally display the incoming count; that is, the number of pulses that arrive between self-check pulses. This count ranges from 00 to 29.

After the RELAY ON SET POINT key is pressed for two seconds, the RELAY ON SET POINT will be displayed. If no further keys are pressed, this display will disappear in four seconds and the incoming count will again be displayed. If the RESET key is pressed, the display will return immediately to displaying the incoming count.

While the RELAY ON SET POINT is displayed, you may increase or decrease the setting by using the INCREASE and DECREASE arrow keys. The displayed value of the RELAY ON SET POINT is live; that is, if the relay is off and the adjusted value crosses the current flame signal count, the relay will turn on immediately (FFRT settings are ignored). This immediate response can be seen if the count is low and the RELAY ON SET POINT is set above it; if the RELAY ON SET POINT is then adjusted down to the count level, the FLAME ON relay will turn on. You may press the STORE key and store the displayed RELAY ON SET POINT value, or return to displaying the incoming count (without storing the displayed value) by pressing RESET. Or, you may simply wait for four seconds without pressing any keys, and the signal processor will then return to displaying the count without storing the changed RELAY ON SET POINT value. If you wish to extend

the display time, you can press the RELAY ON SET POINT key again; the display will time out four seconds after this key is released if the INCREASE and DECREASE keys are not used.

The key labeled RATIO (%) RELAY OFF/RELAY ON is used to set the RELAY OFF SET POINT at some percentage of the RELAY ON SET POINT. This percentage is adjustable from 20% to 80%. For example, if the RELAY ON SET POINT is set to 16 and the RATIO (%) is set to 50% (the factory default values) the relay will close if the displayed count goes to 16 or higher and open when the count drops to 08 or less for one to three seconds, depending on the FFRT (Flame Failure Response Time) setting. The adjustment of this RATIO is live also. Adjustments will cause the Flame Relay to open immediately, ignoring FFRT settings.

You may store the displayed RATIO by pressing the STORE key. If there is no up or down activity from the INCREASE or DECREASE keys for four seconds, and no further presses of the RATIO key to keep the RATIO displayed, the RATIO display will disappear and the old ratio set point will take effect.

AUTOMATIC SETUP – MODEL 700 ONLY

With this feature, the Model 700 sets the RELAY ON SET POINT, the RATIO, and the VIEWING HEAD GAIN automatically. Calculations for these settings are carried out in the Model 700 as the operator takes the system through BURNER ON and BURNER OFF sequences. The Model 800 does not have this feature.

First, adjust the RELAY ON SET POINT to get the FLAME ON relay to turn on.

Press BNR-ON SEQ START/END key for two seconds. If the FLAME ON relay is not on, the display will show “bo” (burner off); press RESET to clear this. If the FLAME ON relay is on, the ON SEQ LED will start flashing slowly and the numeric display will start counting down from 59 while the processor takes data at one reading per second. The FLAME ON relay will remain pulled in if the flame is present, according to the current settings, until valid new values are obtained. You can press the same button, BNR-ON SEQ START/END, to end the data sampling as soon as you wish, but you should ensure that an adequate number of data samples has been taken. At least 30 seconds of BNR-ON data sampling is recommended; ten seconds is a minimum. The software will not respond to a second press of the button for 10 seconds. You may also press RESET while the data sampling is occurring; the data sampling process will be aborted and the old values will remain in effect.

After BNR-ON data sampling is complete, the OFF SEQ LED flashes. You should turn off the burner and immediately press the BNR-OFF SEQ START/END key (a two-second press is not required). The displayed timer then counts down from 29. You may interrupt this process, but at least 15 seconds of BNR-OFF data sampling is recommended. The data sampling process can be aborted by pressing RESET, in which case the data for both BNR-ON and BNR-OFF will be discarded and the previous values will remain in effect.

If the data is good, that is, the computed ratio is 71% or less when BNR-OFF data sampling is complete, the display shows the ratio in % for one second, followed by “- -” to indicate a successful setup. The signal processor then turns on the AUTO SET LED to verify that the values stored internally were derived from the BNR-ON/BNR-OFF data sampling sequence.

If the data received is marginal, with the computed ratio ranging from 72% to 80%, the display alternates between “AC” and the computed ratio, for example, “AC” and “75”. You can press either the ACCEPT RATIO or RESET keys. If you press ACCEPT RATIO, the display responds with “- -”, the ratio is stored, and the AUTO SET LED is turned on. If you press RESET, the display returns to the counts, both of the AUTO SETUP LEDs are turned off, and the old set points are used.

If the ratio computed as a result of BNR-ON and BNR-OFF data sampling is higher than 80%, the display will show “UA” (unacceptable), alternating with the unacceptable ratio. For example, if the computed ratio was 93%, the display would alternate between “UA” and “93”. You must press RESET to clear this; the old values for RELAY ON and RATIO will remain in effect.

The values can be worse than just unacceptable. If the flame relay drops out while reading BNR-ON values, the display will show “bo”, and data-taking will be aborted. Other faults, such as a BNR-ON flame signal that is too low to use, or BNR-OFF readings that are too close to the BNR-ON readings, can result in “rE” being displayed. You should then press RESET.

The signal processor also adjusts the viewing head gain during the BNR-ON and BNR-OFF data sampling sequence, except when an older UV viewing head is being used. Normally, after the sequence, the display should read about 20, because the gain has been adjusted to give this reading. If it is less than about 18, you should find that the gain has been set to 9; if it is more than about 22, you should find that the gain has been set to 1.

RELAY ON SET-POINT	16
RATIO (%) RELAY OFF/RELAY ON	50%
FFRT (FLAME FAIL RESP TIME)	1 SEC
0-20mA/4-20mA OPTION	4-20mA

Table 1

Once the values have been stored through this sequence, you can check the RELAY ON SET POINT, the RATIO, or the GAIN by pressing the appropriate key for two seconds. However, if you attempt to change these values by pressing the INCREASE or DECREASE keys, the display will show “CF” (confirm), and the AUTO SET LED will flash rapidly. To confirm the desired change, press the RELAY ON SET-POINT key, the RATIO key, or the SET GAIN key a second time. Alternatively, you may press the RESET key to discontinue your attempt to make changes, or just wait four seconds for the time out to occur.

If you confirm that you wish to make changes, the values will change when you use the INCREASE or DECREASE keys. Meanwhile, the AUTO SET LED will be flashing. The AUTO SET LED will go out only if you store the changed values; if you did not store the changed values, the AUTO SET LED will light and the old values will remain in effect.

If values were obtained automatically, -that is, if the AUTO SET LED is on and you press the BNR-ON SEQ START/END key- the display will also show “CF”. If you then press the BNR-ON SEQ START/END key again, the signal processor will begin the BNR-ON data sampling sequence.

FILTER SELECTION FOR IR VIEWING HEAD

If a good count ratio between BNR-ON and BNR-OFF cannot be obtained when using an IR viewing head - particularly when monitoring oil flames- an IR viewing head with the High Frequency (-HF) filter option is recommended. The standard IR viewing head responds to flicker frequencies above 33 Hz; with the -HF option, the IR viewing head responds to flicker frequencies above 155 Hz.

LOADING FACTORY DEFAULTS

If the AUTOSSET LED is not on, pressing the LOAD FACTORY DEFAULTS key will result in the values

shown in Table 1 being loaded and stored in EEPROM:

In the Model 700, if the AUTO SET LED is on when the LOAD FACTORY DEFAULTS key is pressed, "CF" will be displayed. Press the LOAD FACTORY DEFAULTS key again to confirm your request, or press RESET to abort your request. If you load factory defaults, the AUTO SET LED will be turned off.

The Model 800 does not have an automatic mode in which it calculates set points, so confirming an overwrite of calculated set points is not part of the Model 800 applications software.

SETTING FFRT – MODELS 700 AND 800

You may press the FFRT key to change the Flame Failure Response Time over the range one to three seconds, using the increase and decrease keys on the Model 700, or from the application software or setup programmer available for the Model 800. These changes, however, are not live; they take effect only if the STORE key is pressed. FFRT values do not relate to the RELAY ON SET POINT and RATIO values, so if the AUTOSSET LED is on in the Model 700, confirmation is not needed to change the FFRT setting.

0-20 MA/4-20 MA OPTION – MODELS 700 & 800

An analog output current is provided for operating a remote meter or other instrumentation. The load resistance should not exceed 360 Ohms for the Model 700 or 100 Ohms for the Model 800. The resistance can be chosen to give the desired voltage swing. For example, if 2V is desired for a 20 mA output, a 100 Ohm resistor would be used.

The analog current output can range from 0 to 20 milliamps, or from 4 to 20 milliamps. A change can be made by pressing the 0-20 MA/4-20 MA OPTION key and using the INCREASE and DECREASE keys. This change can also be made from the setup programmer or application software for the Model 800. The display will show "02" or "42" as appropriate. This function is live; the operative range changes as soon as the displayed selection is changed. But, as with the other functions, you should press STORE for a change to be stored in the signal processor's EEPROM.

The analog current output is scaled according to the RELAY ON setting. It is scaled so that, if the counts coming in are at a count rate equal to the RELAY ON setting, the current output is approximately 13 MA when the range selected is 0-20 MA, and about 14.6 MA when the range selected is 4-20 MA.

Note that the actual maximum level for the current output is 19.8 MA. It is slightly less than 20 MA so that a data sampling system will not switch ranges when the current reaches a maximum.

Confirmation is not requested if the 0-20/4-20 setting is changed when the AUTOSSET LED is on.

LOCKOUT OR FAULTY VH INDICATION

If the viewing head produces any pulses during the last one third of the self-check time, the relay will immediately drop out, the display will show "LO" (lockout), and the FAULT LED will flash on and off rapidly. On the Model 800, this will be indicated by the green LED flashing rapidly. Exit lockout by pressing RESET. If a pulse or pulses come in during the last one third of the self-check time while the automatic data sampling is taking place, the automatic process will be aborted, the relay will be opened if it was closed, the display will show "LO" (lockout), and the FAULT LED will flash on and off rapidly. Press RESET to exit this. If a viewing head is disconnected, the display will show "L1." Reconnect the viewing head and press RESET.

PANEL LOCK

A pattern of key presses will result in the panel being locked so as to block the storage of any changes to the values stored in the signal processor. With the panel locked, values may be examined, but the signal processor will not respond to the STORE key.

The panel should be locked after the set points are set. Contact the factory to obtain the procedure to lock or unlock the panel.

The Model 800 processor does not allow any values to be changed other than by using the setup programmer or application software.

PANEL LOCK WITH NO VH CONNECTED

When the signal processor is working with an intelligent viewing head, it expects to have continuous communication with the viewing head. If the viewing head is disconnected, communication is lost, the display is made inoperative, and no settings can be examined or changed. Reconnect the viewing head and cycle power to correct this condition.

WORKING WITH OLDER UV VIEWING HEADS

When the signal processor has been set up with an older UV viewing head without communications, the settings may be viewed and changed whether or not the viewing head is connected. But, if the viewing head is

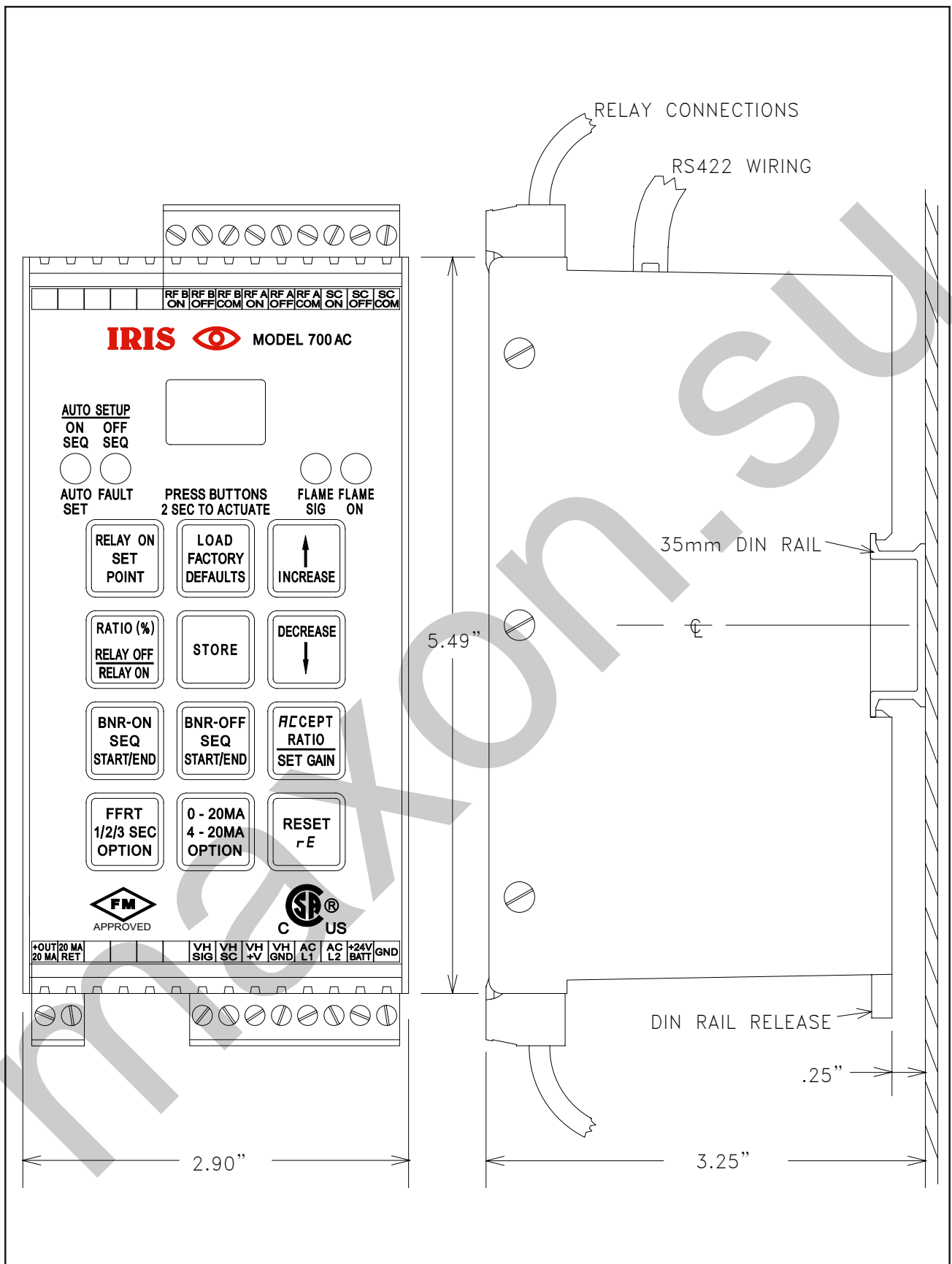

FIGURE 1 - MODEL 700AC SIGNAL PROCESSOR

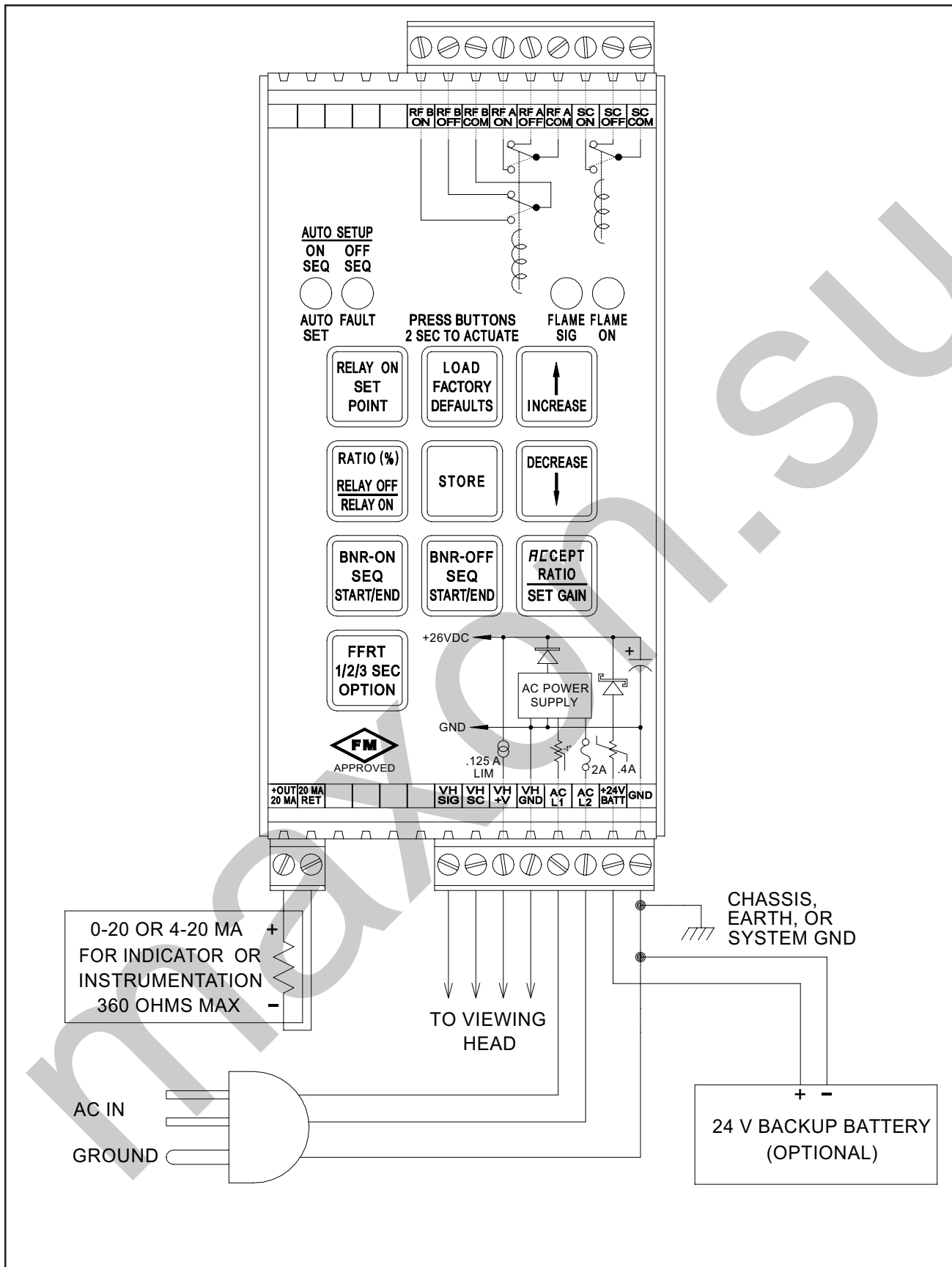

FIGURE 2 - MODEL 700AC SIGNAL PROCESSOR WIRING

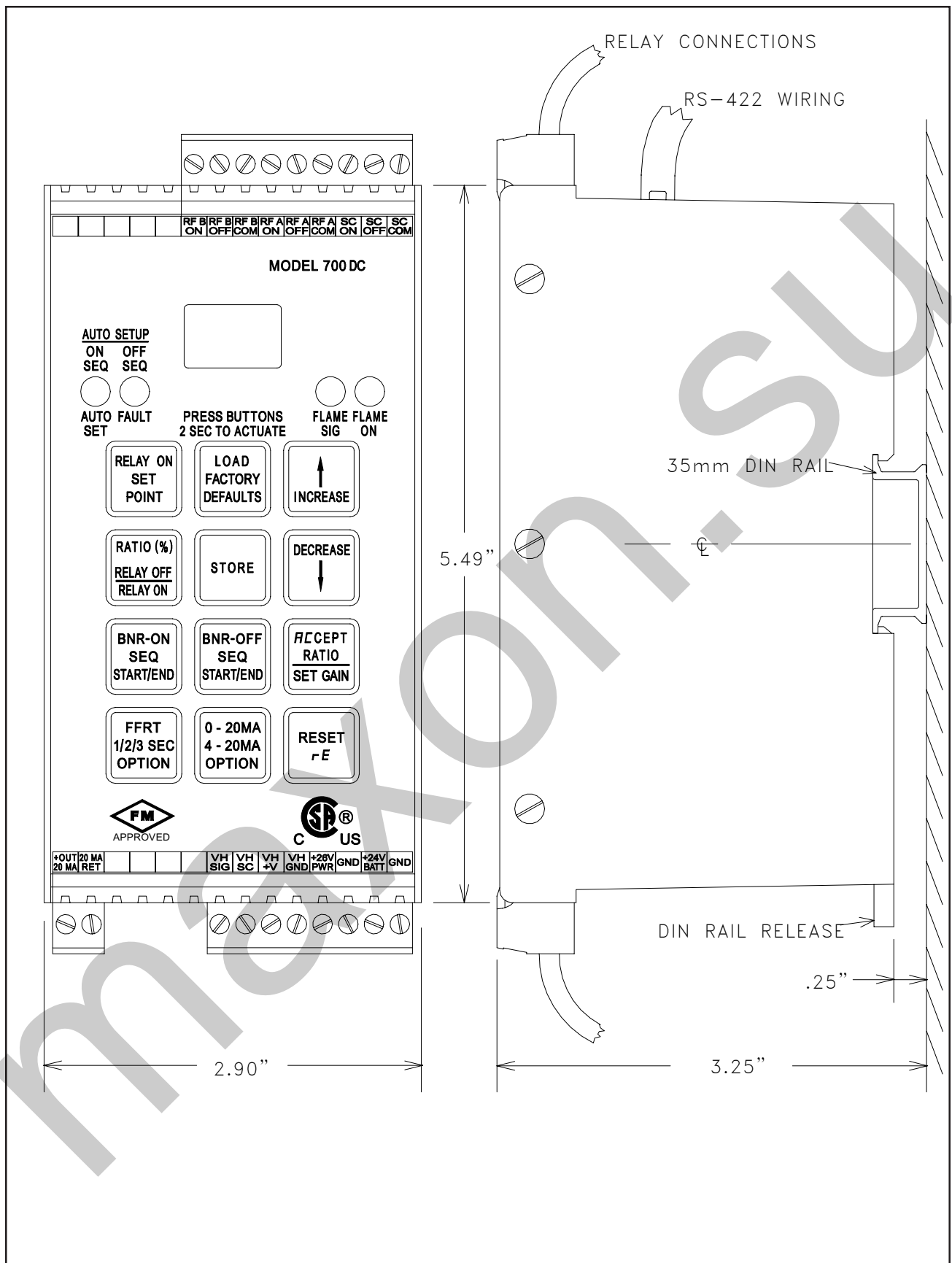

FIGURE 3 - MODEL 700DC SIGNAL PROCESSOR

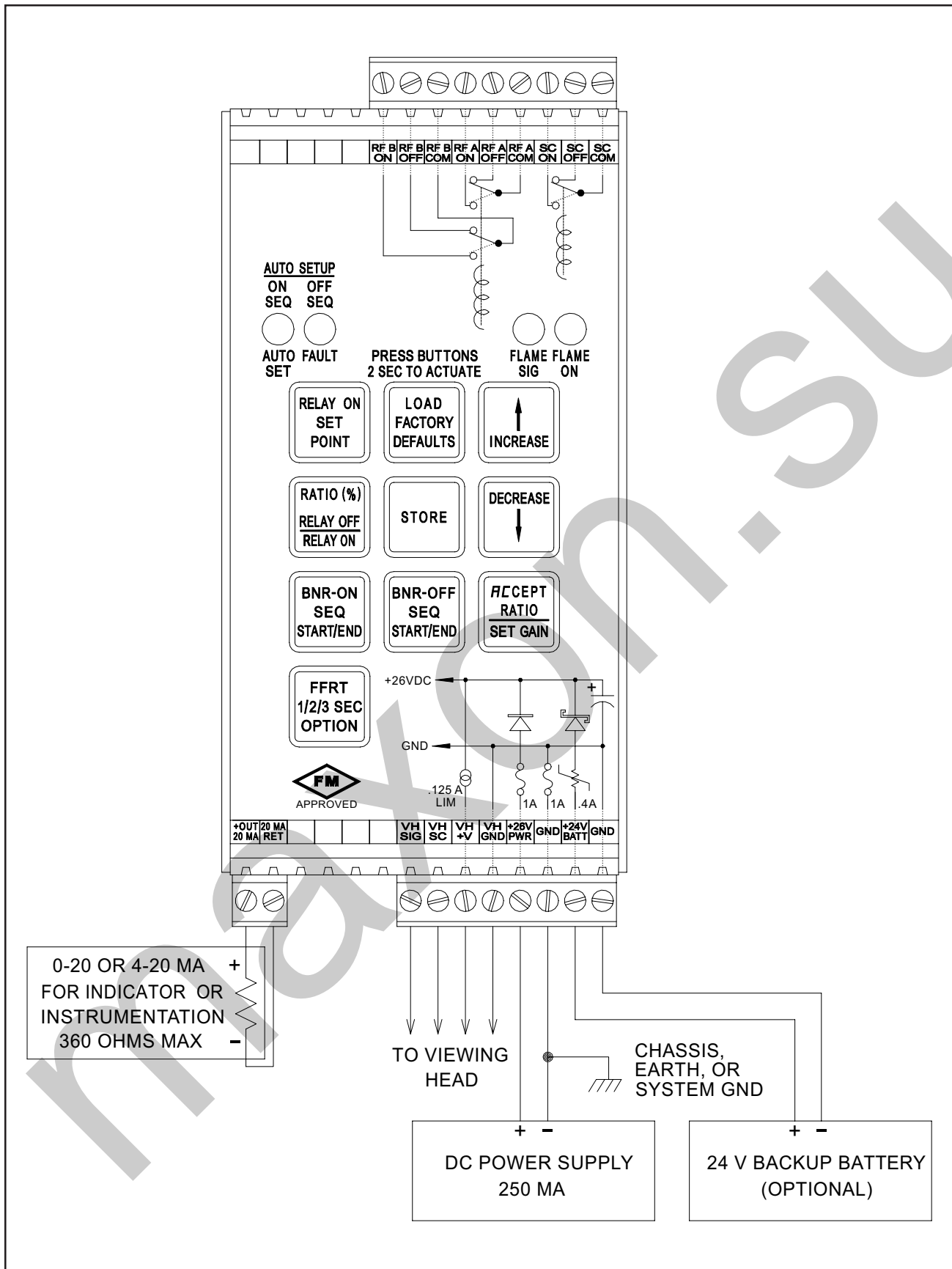

FIGURE 4 - MODEL 700DC SIGNAL PROCESSOR WIRING

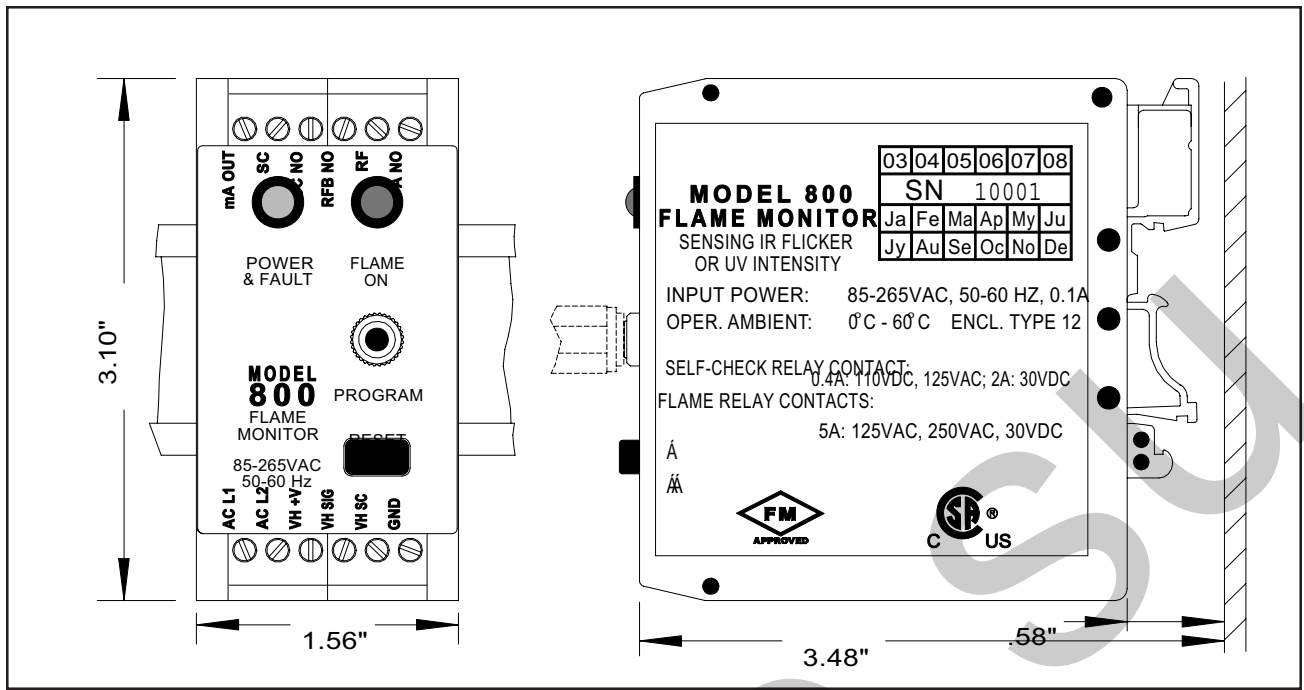

FIGURE 5 - MODEL 800 SIGNAL PROCESSOR ON DIN RAIL

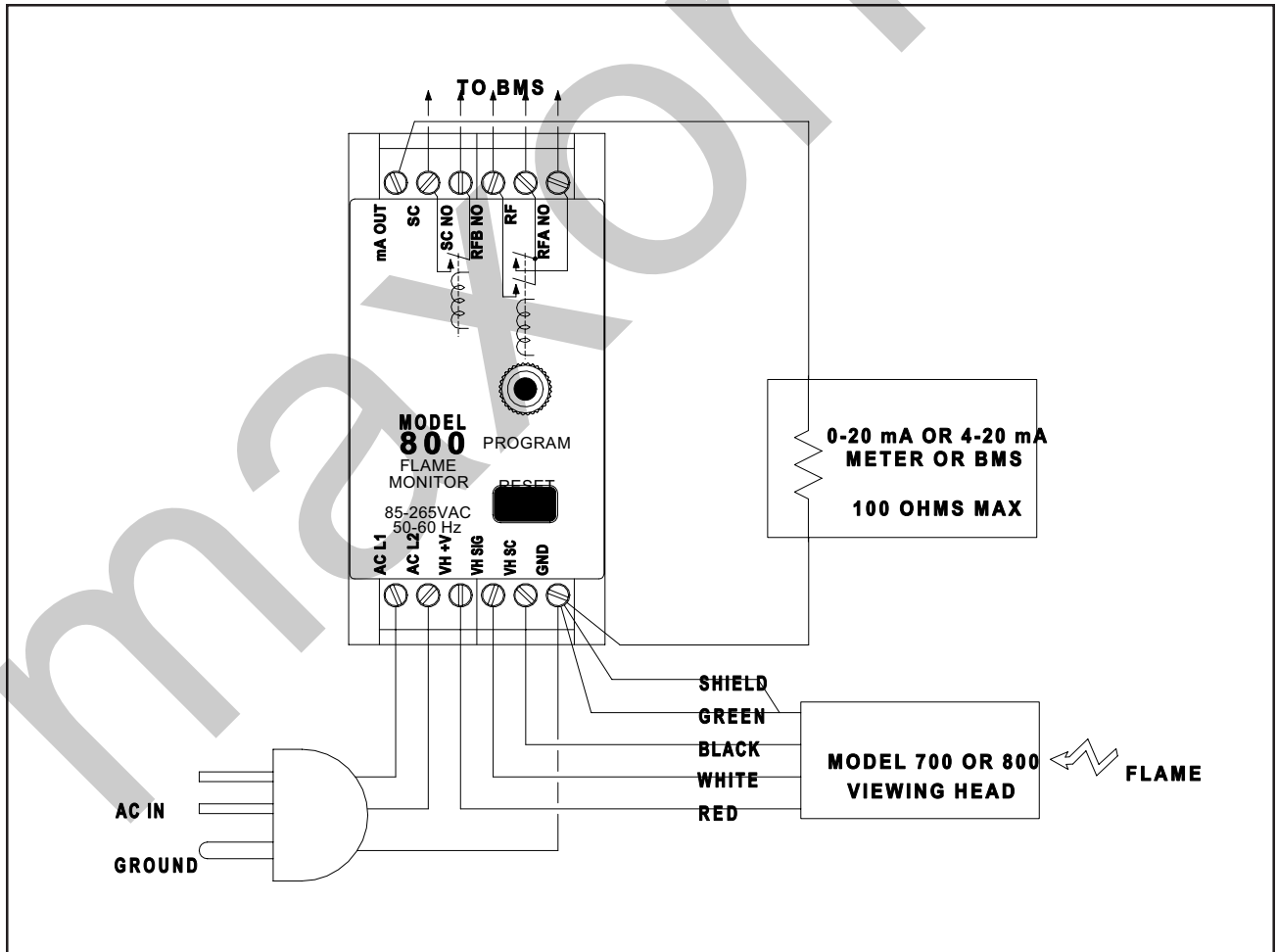

FIGURE 6 - MODEL 800 SIGNAL PROCESSOR WIRING

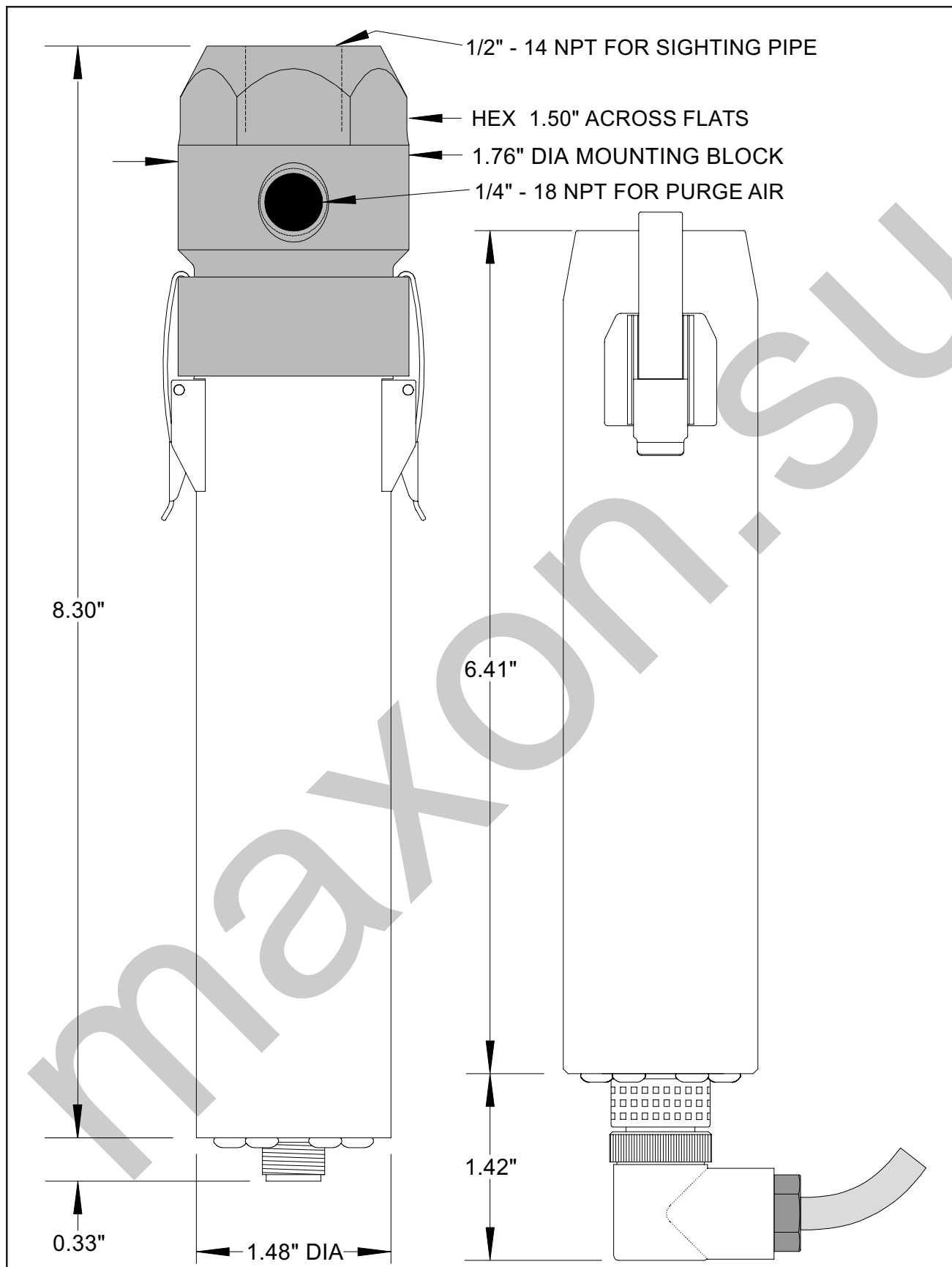

FIGURE 7 - MODELS S702 AND S706 VIEWING HEADS

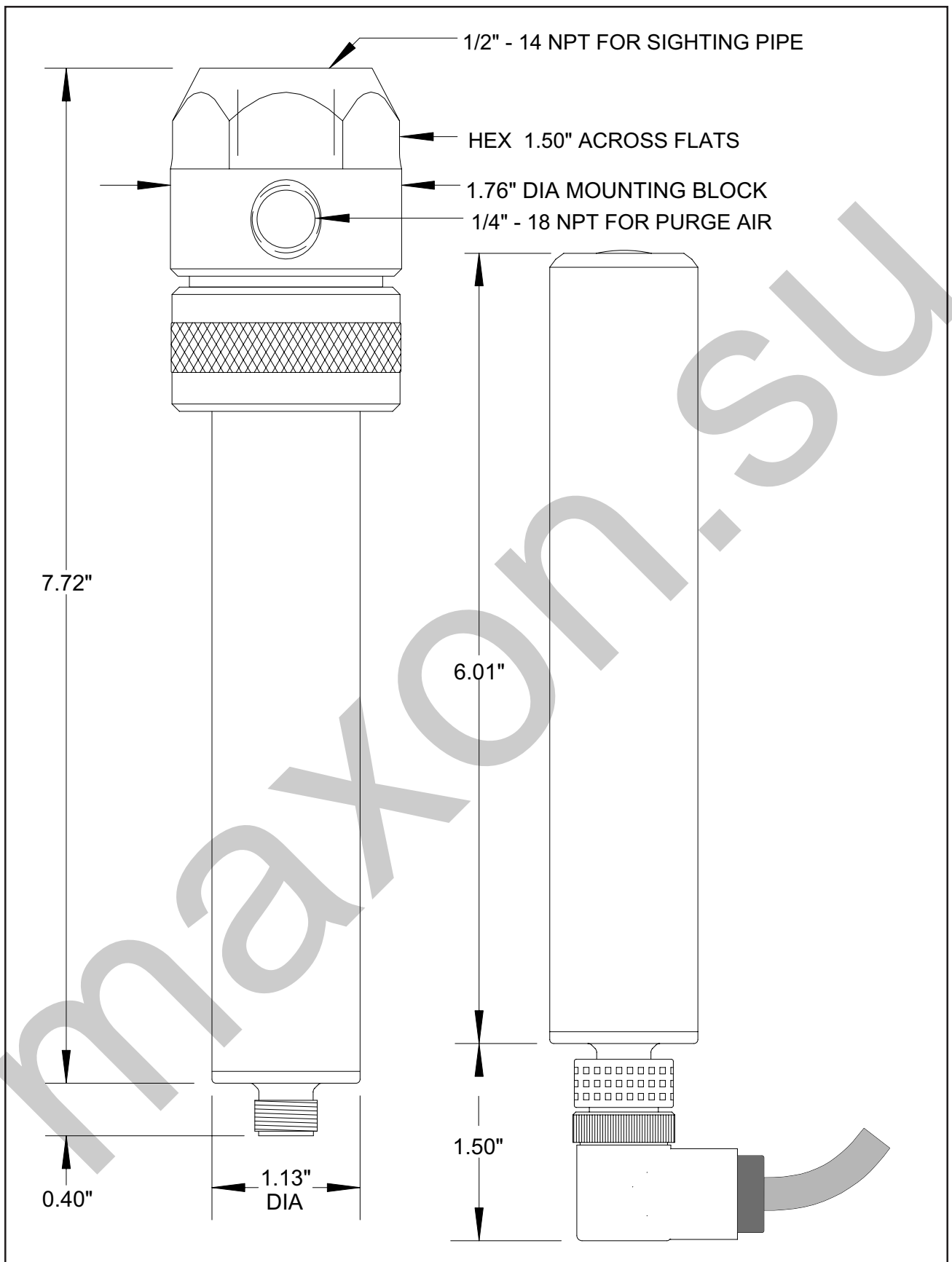

FIGURE 8 - MODEL S802 AND S806 VIEWING HEADS

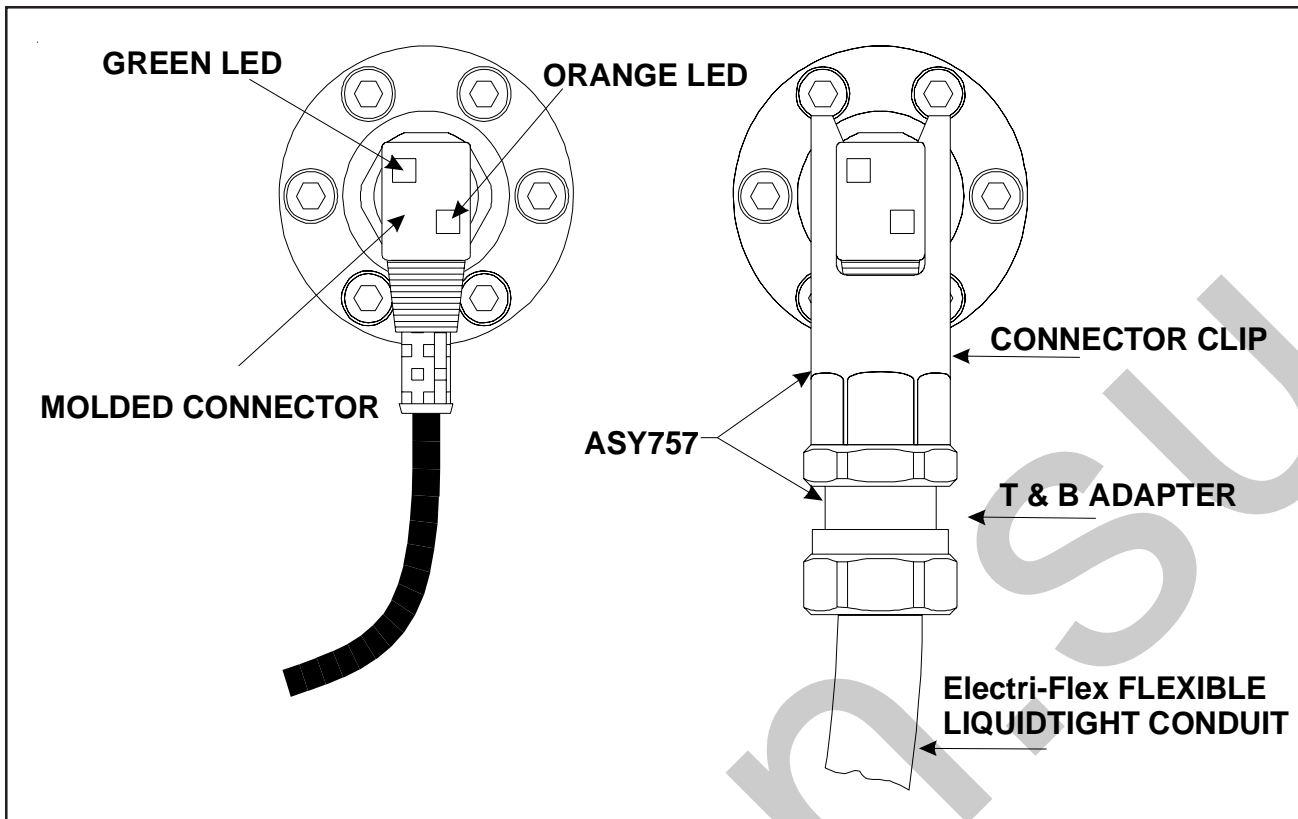

FIGURE 9 - "DISCONTINUED"

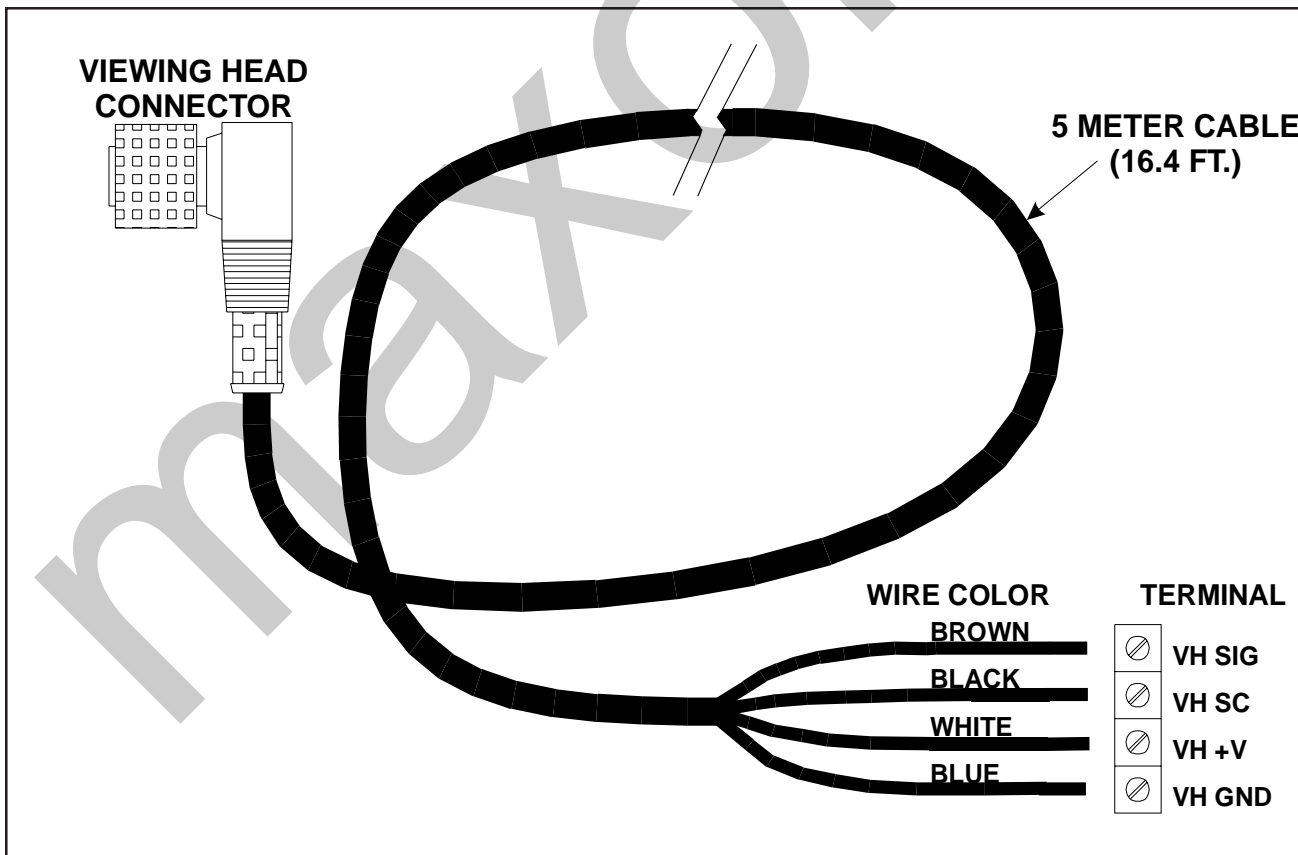

FIGURE 10 - "DISCONTINUED"

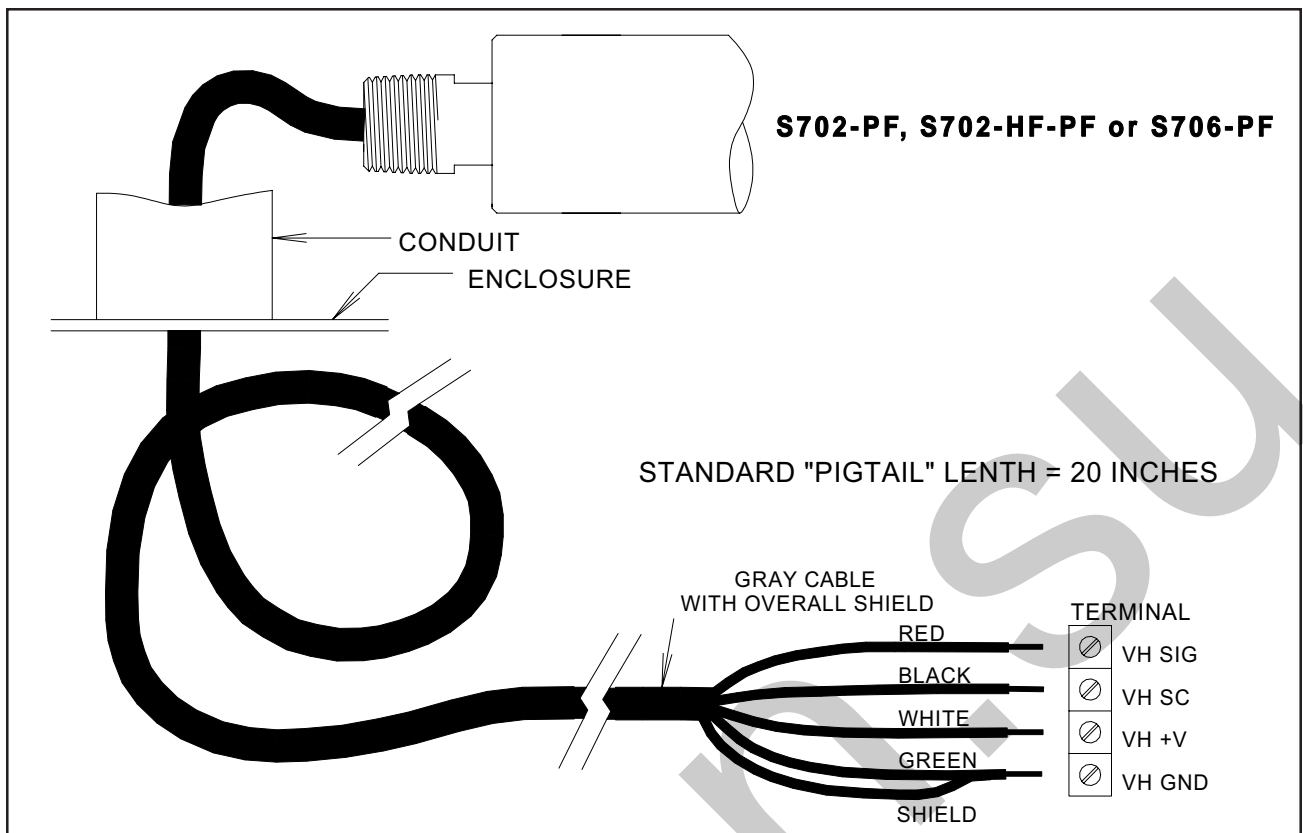

FIGURE 11 - MODEL 700 VIEWING HEAD CABLE WITH 1/2" NPT FITTING

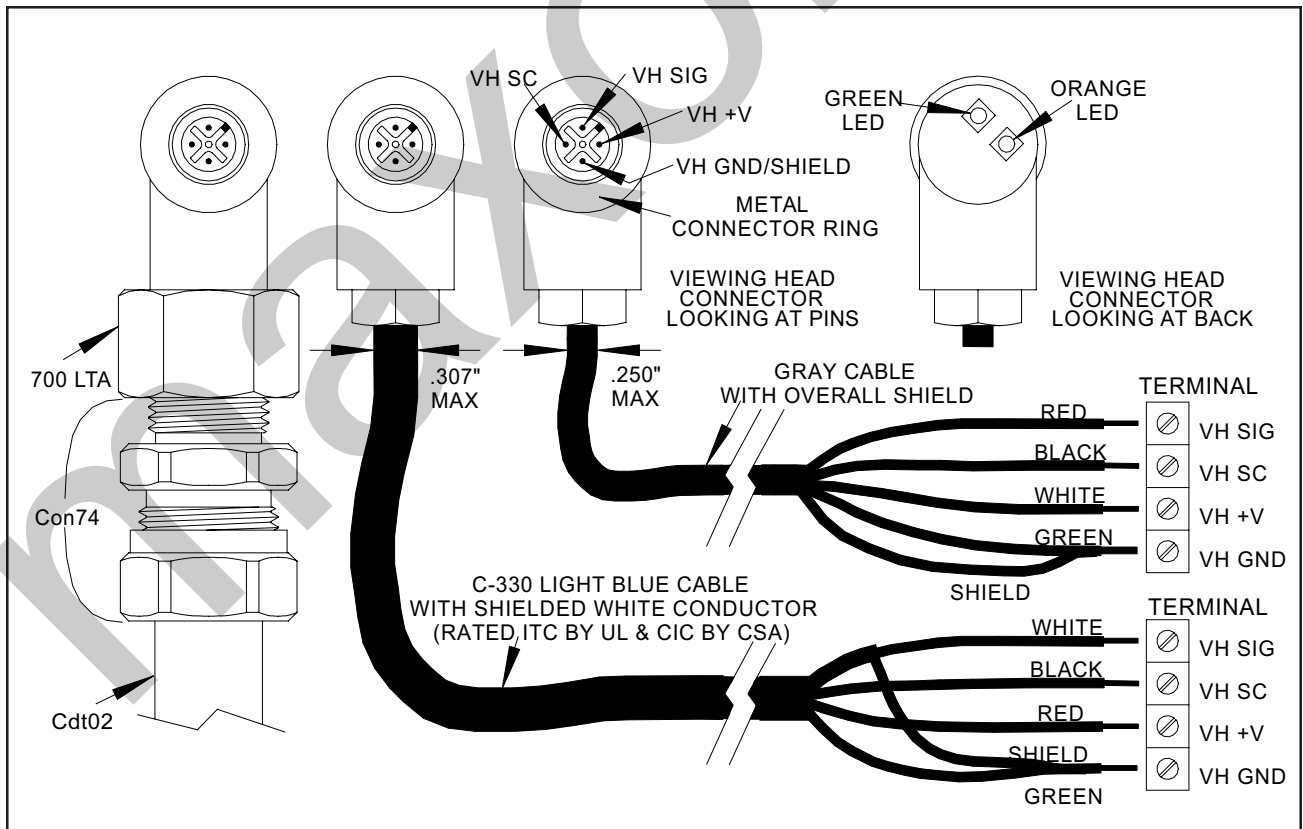

FIGURE 12 - MODEL 700/800 VIEWING HEAD CABLE CONNECTIONS

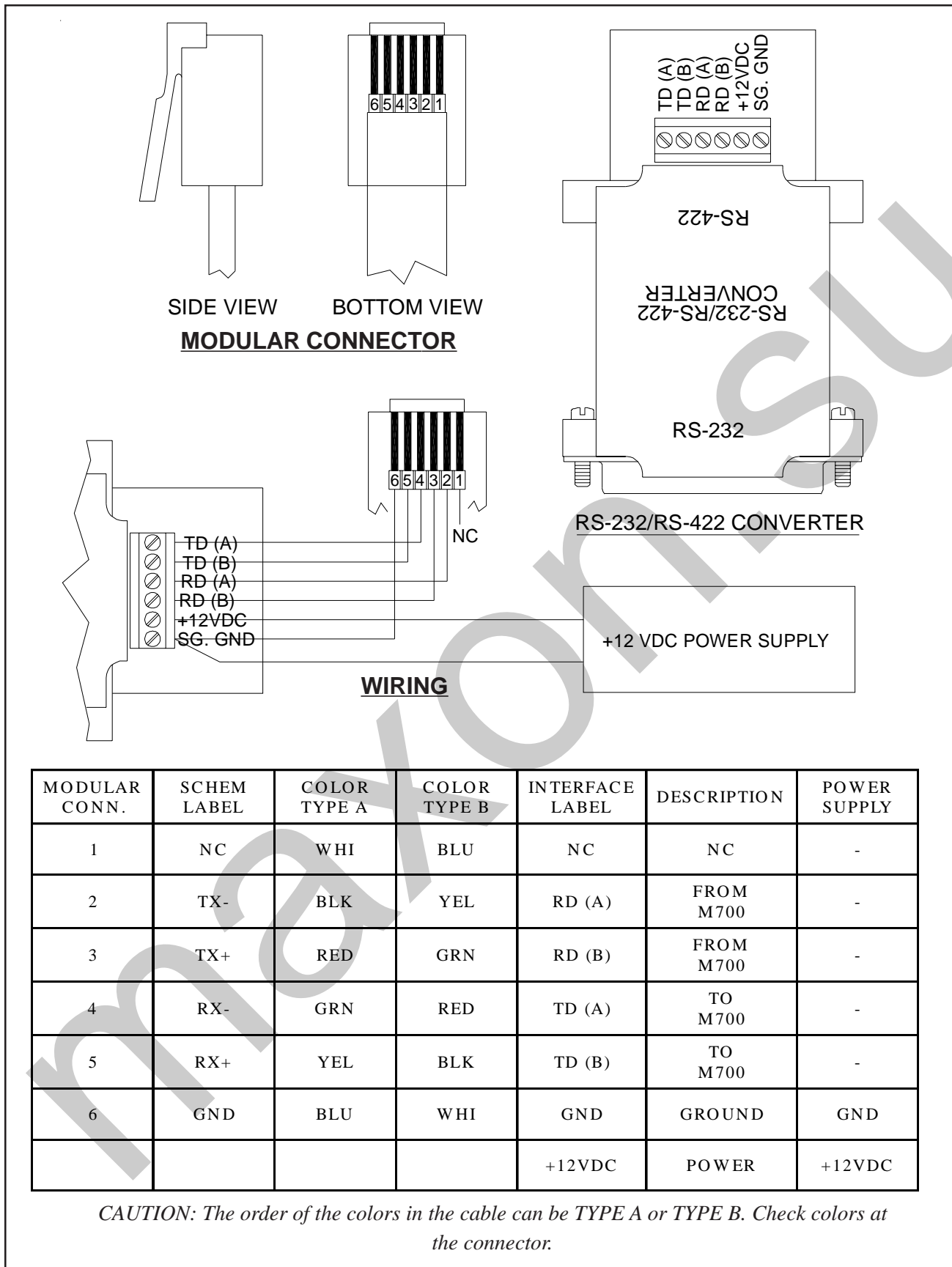

FIGURE 13 - WIRING OF RS-422 TO RS-232 CONVERTER TO MODEL 700 SIGNAL PROCESSOR

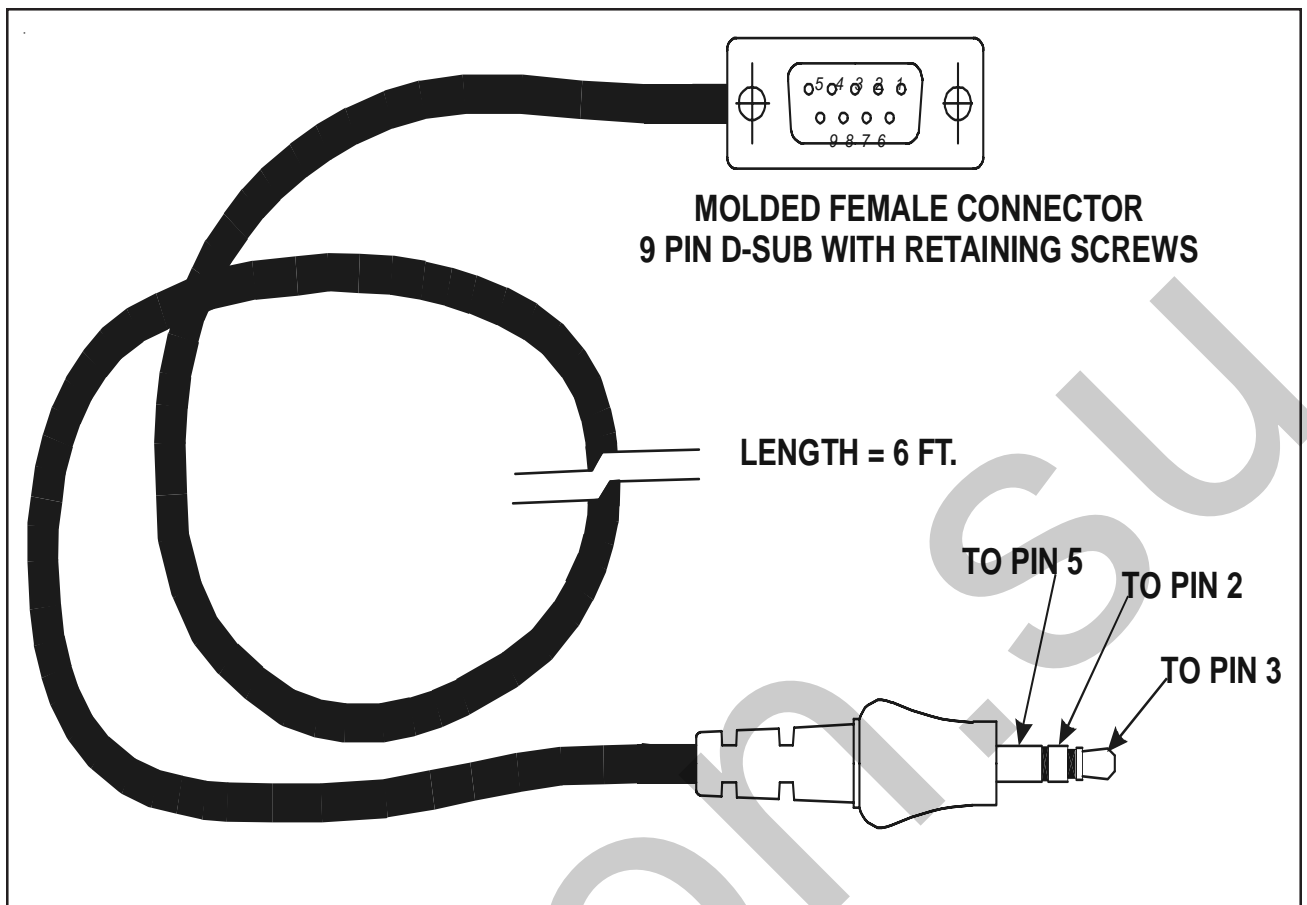

FIGURE 14 - COMMUNICATIONS CABLE FOR MODEL 800 SP

max

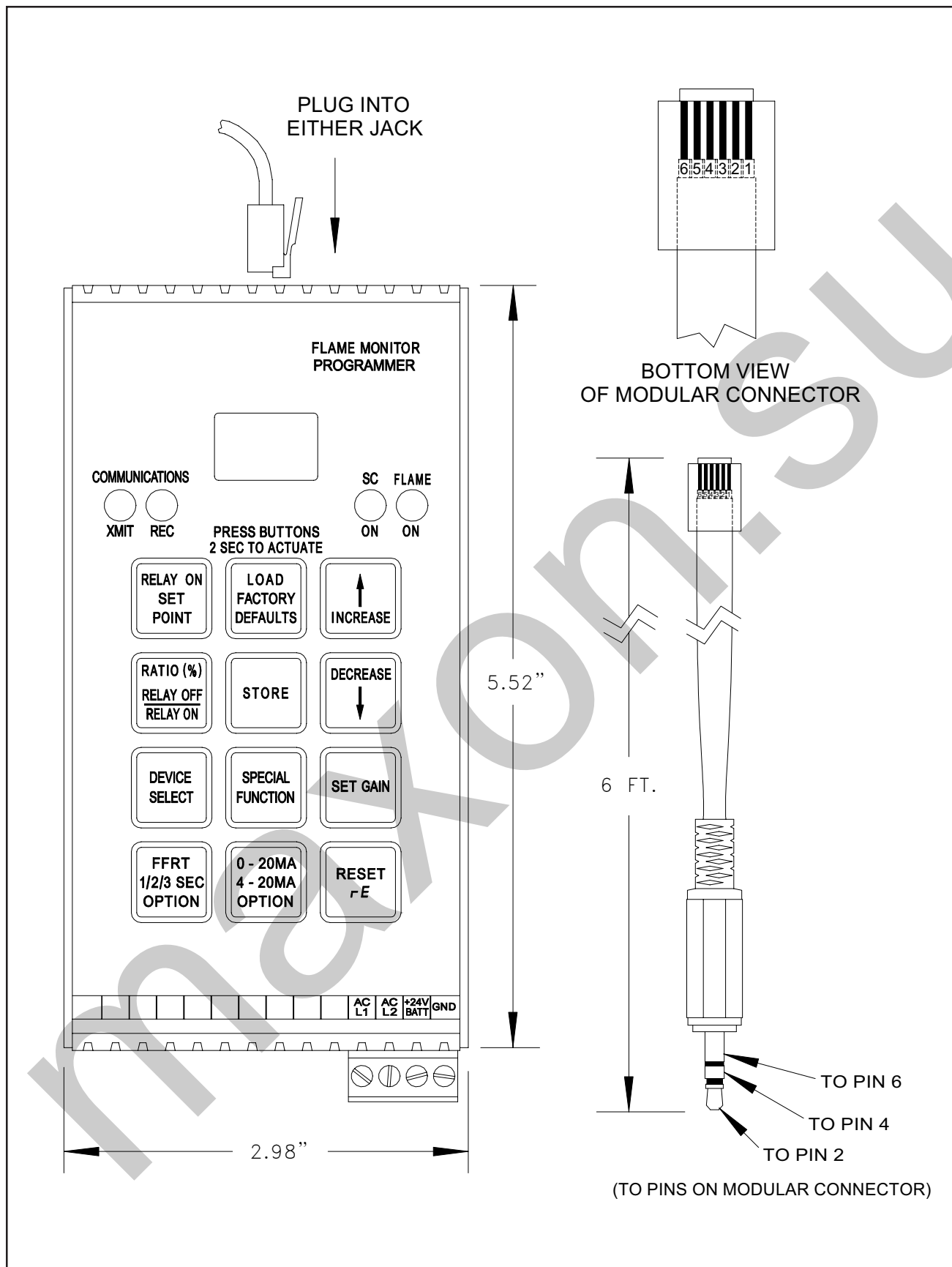
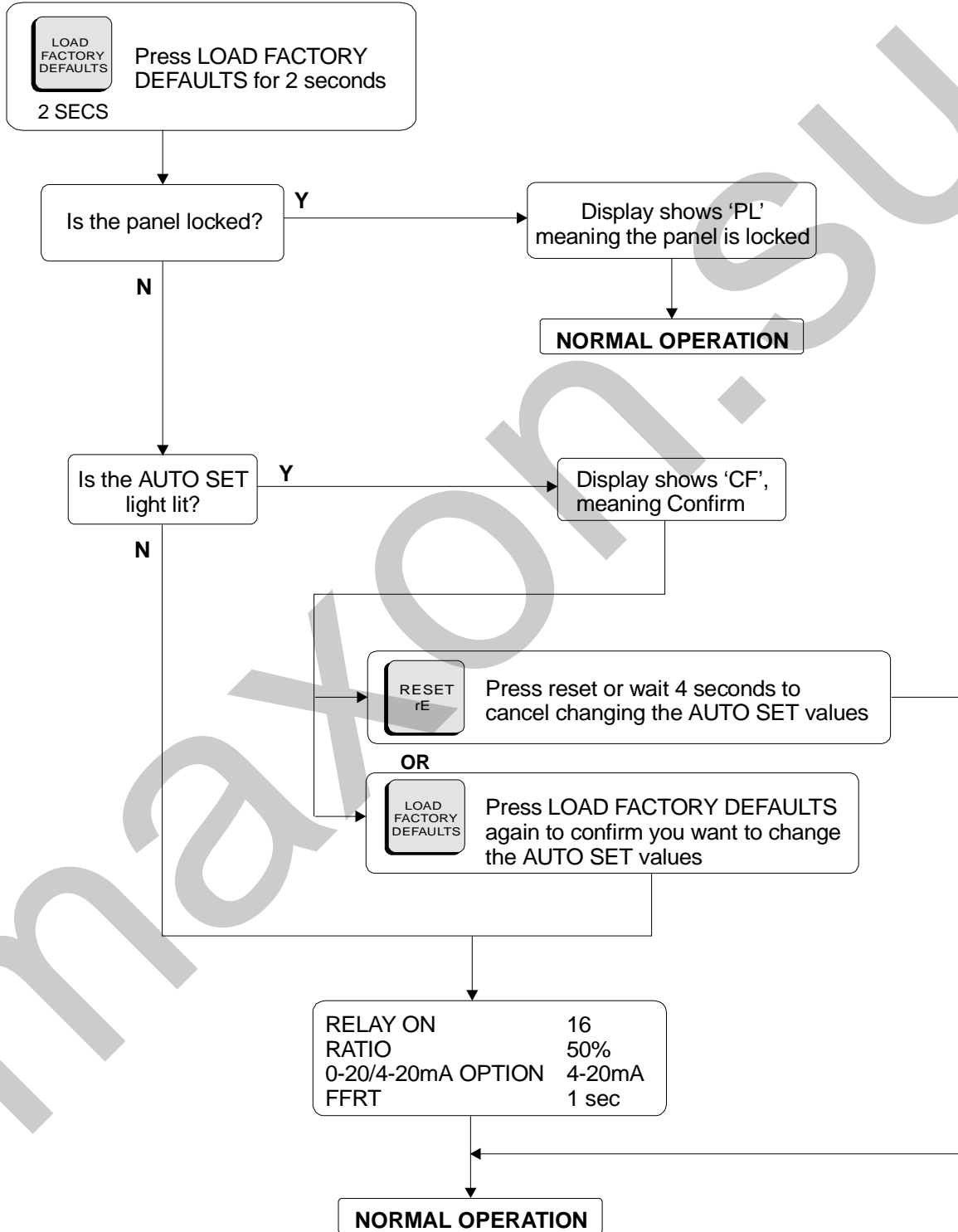

FIGURE 15 - PROGRAMMER AND CABLE

FLOWCHART OF MODEL 700

RESTORING DEFAULT VALUES



FLOW CHART 1 - SETTING FACTORY DEFAULTS

FLOWCHART OF MODEL 700

AUTO SETUP

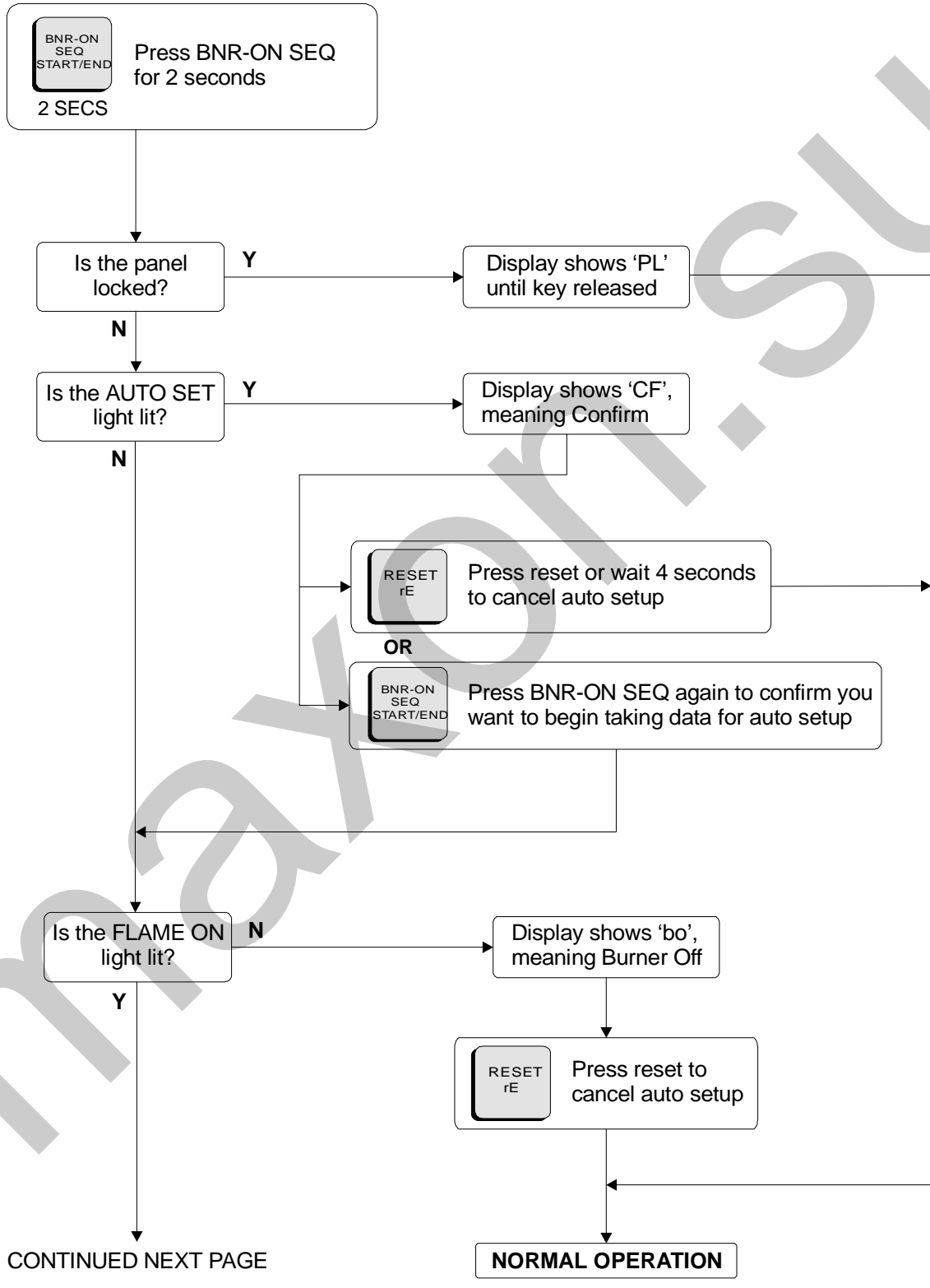

FLOW CHART 2 - AUTO SETUP PAGE 1

AUTO SETUP - PAGE 2

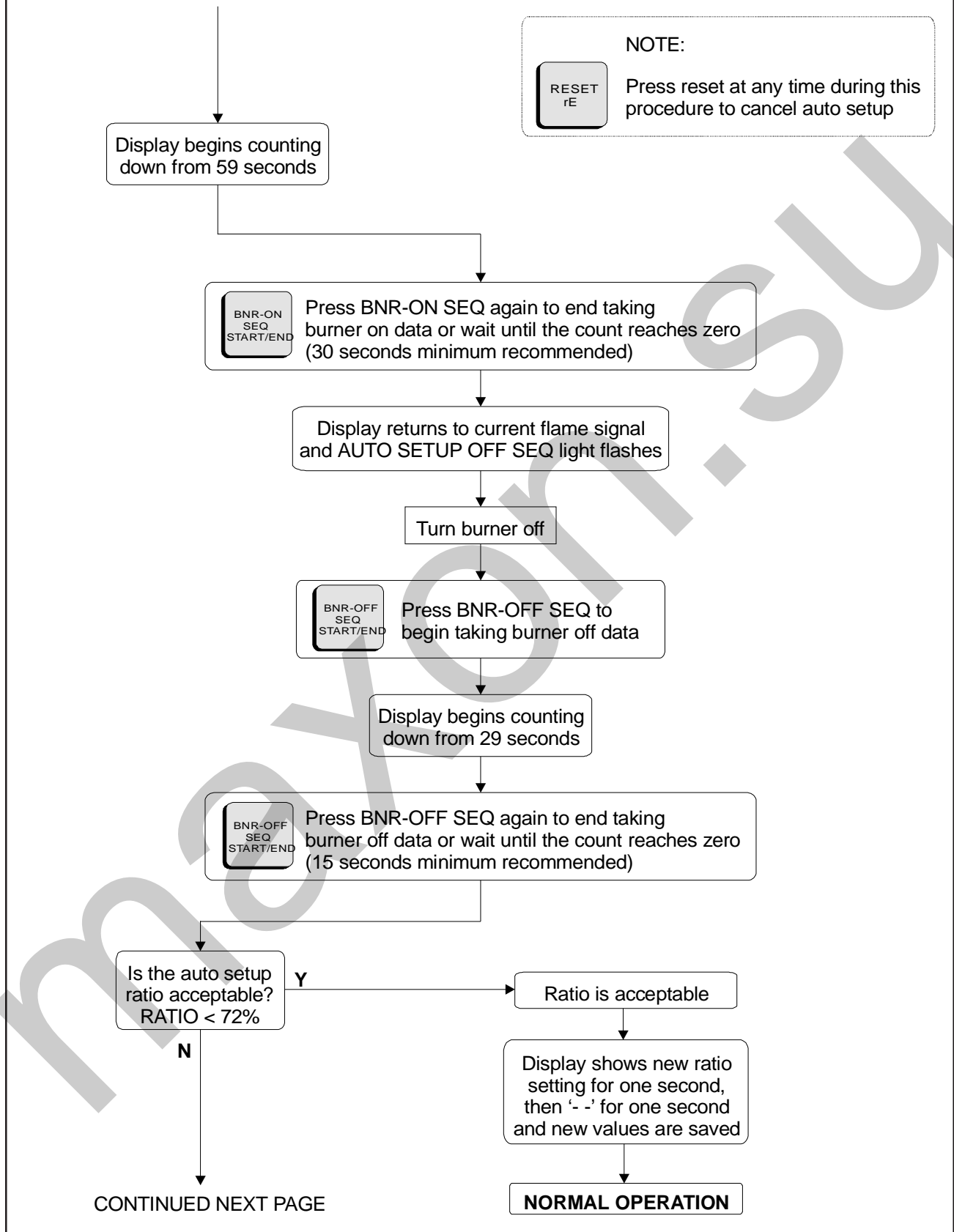

FLOW CHART 3 - AUTO SETUP PAGE 2

AUTO SETUP - PAGE 3

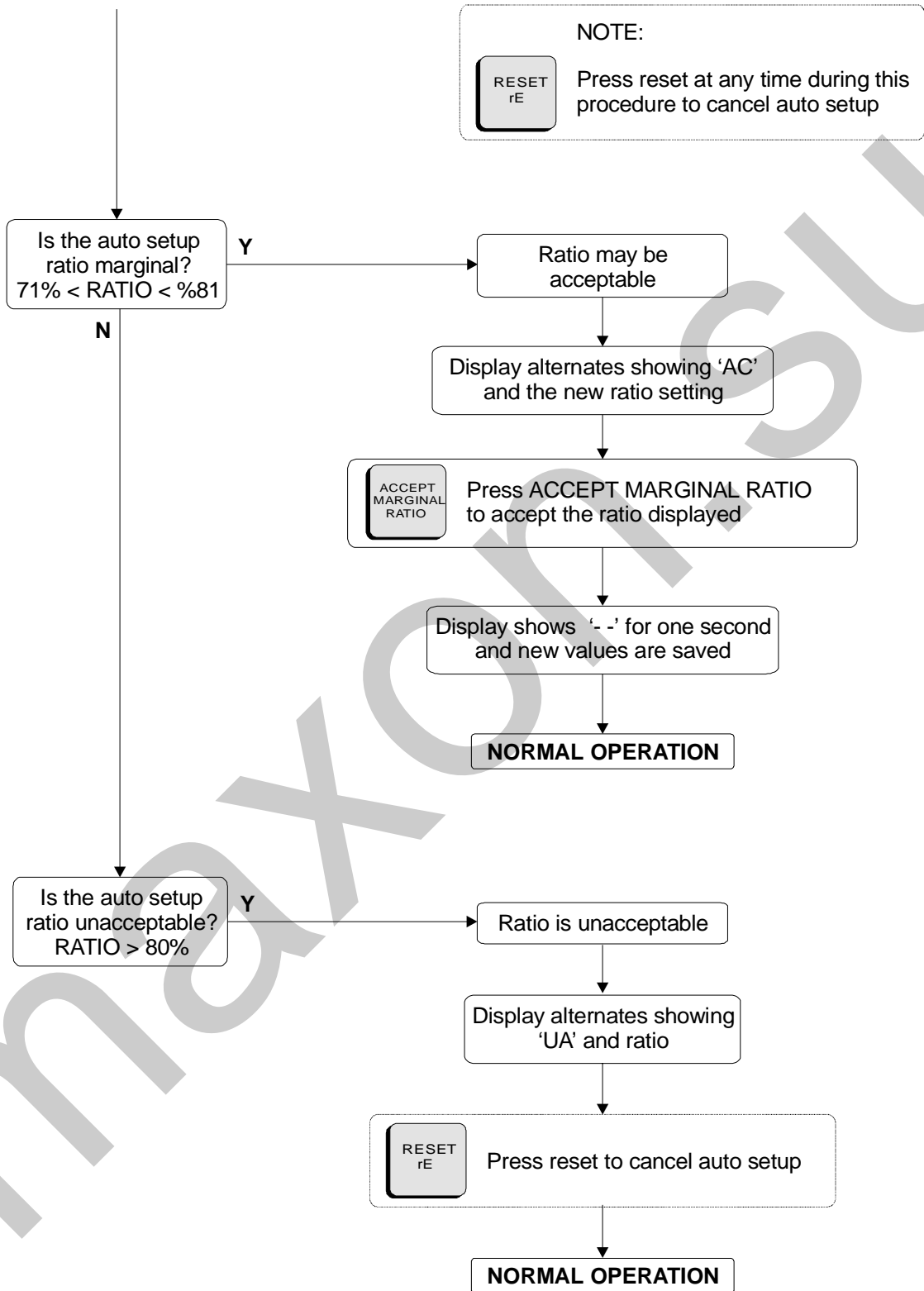

FLOW CHART 4 - AUTO SETUP PAGE 3

FLOWCHART OF MODEL 700

SETTING RELAY ON VALUE

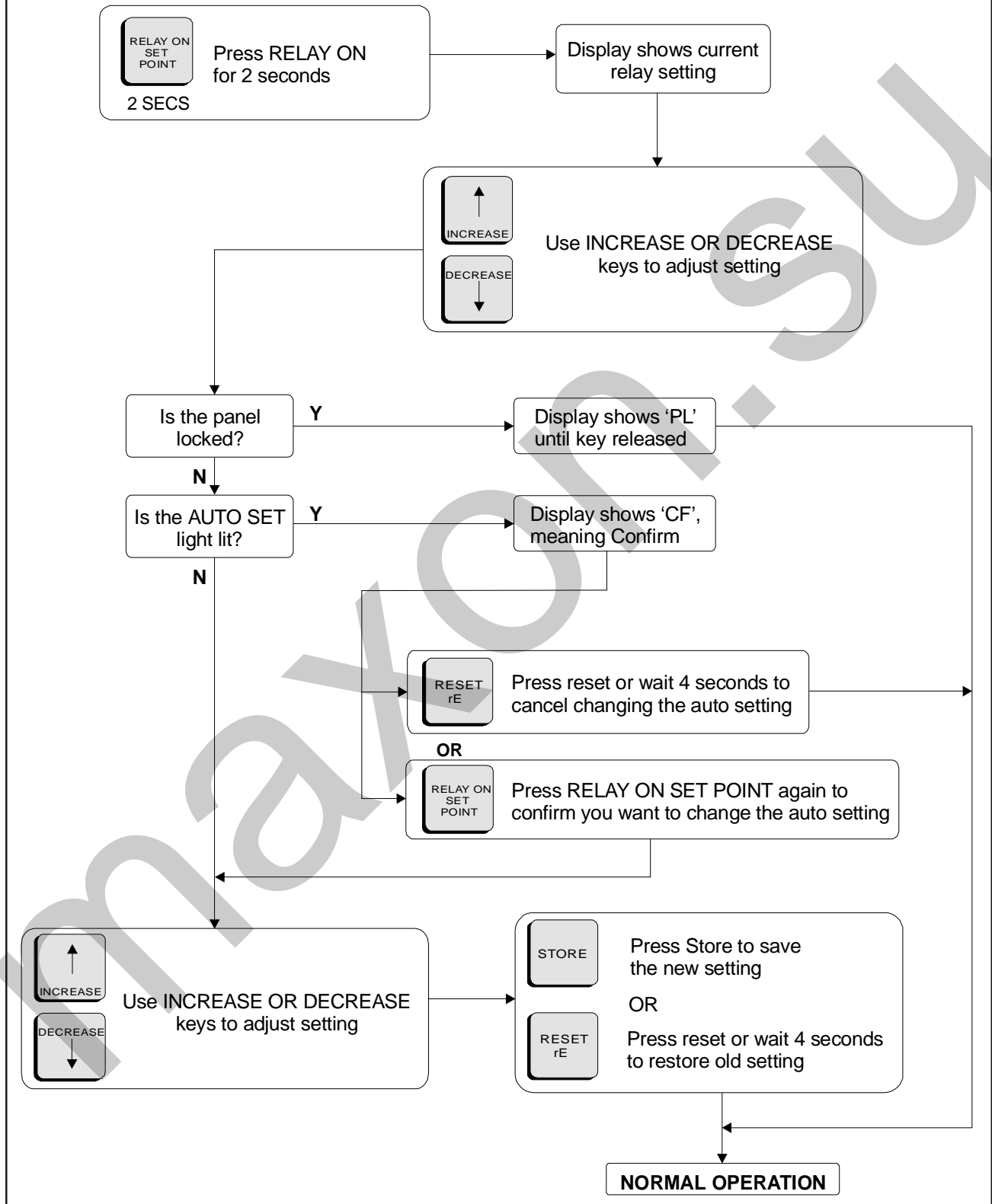

FLOW CHART 5 - MANUAL FLAME ON SETUP

FLOWCHART OF MODEL 700

SETTING RATIO PERCENTAGE

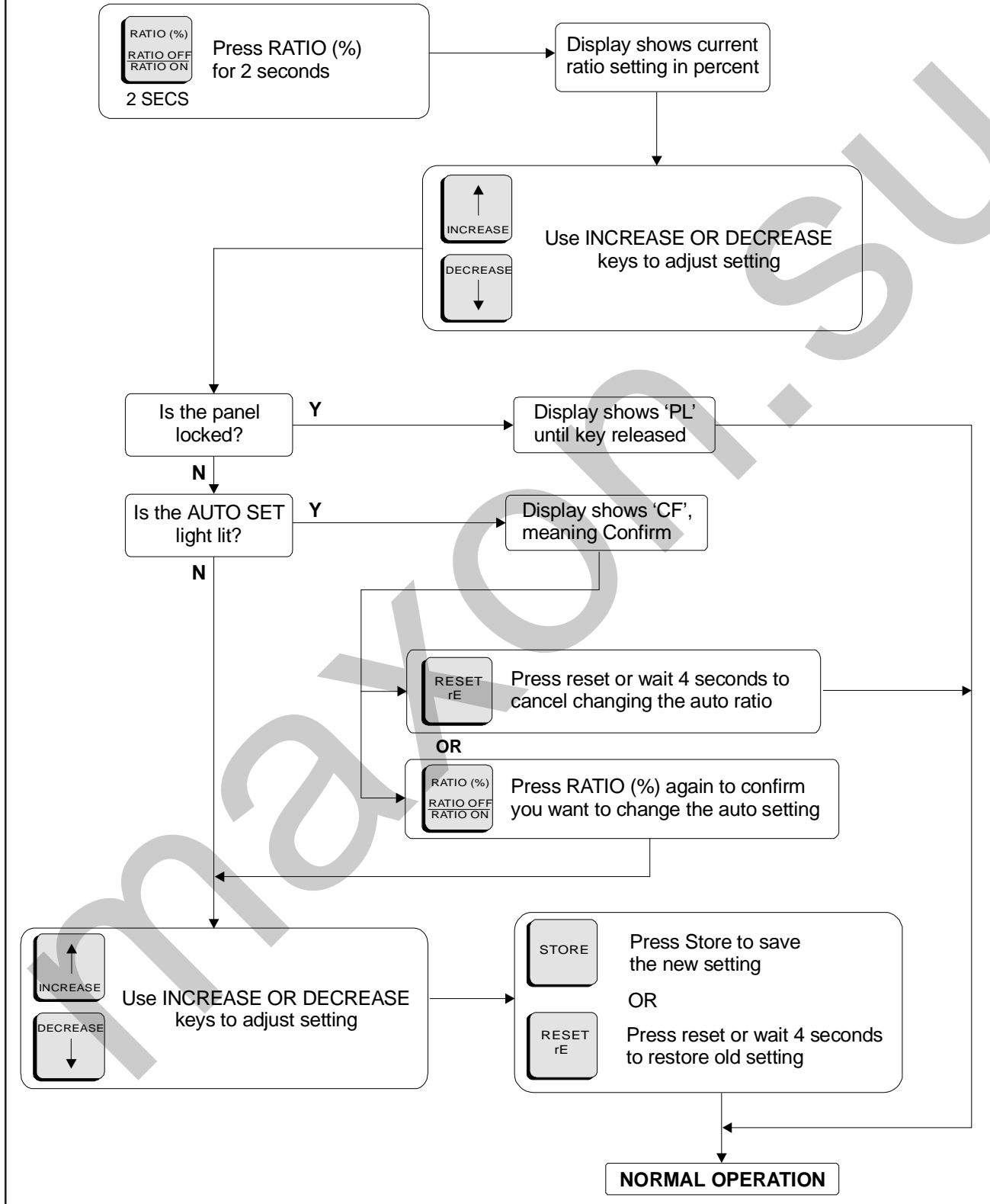

FLOW CHART 6 - MANUAL FLAME OFF SETUP

FLOWCHART OF MODEL 700

SETTING FLAME FAILURE RESPONSE TIME (FFRT)

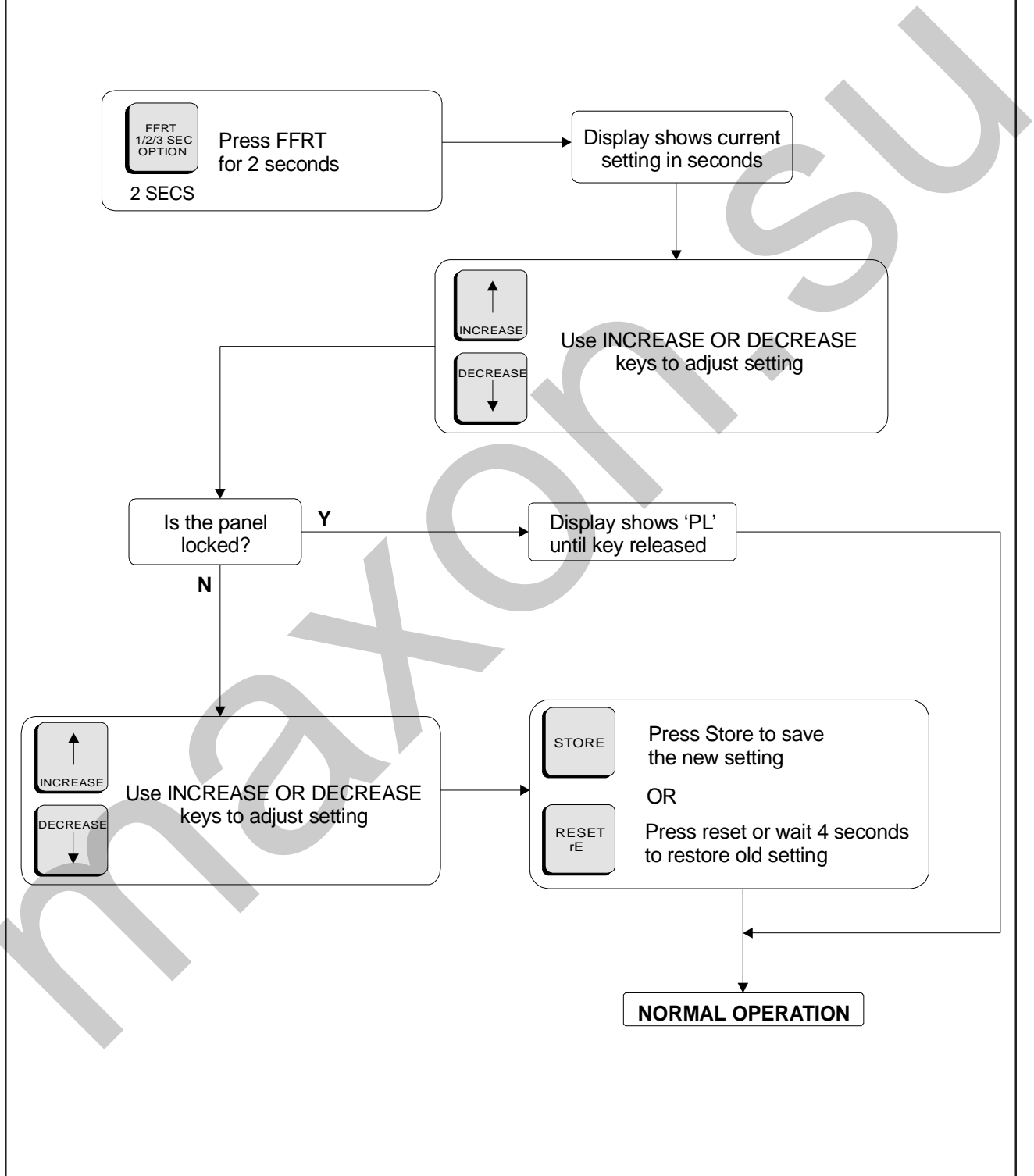

FLOW CHART 7 - FLAME FAILURE RESPONSE TIME (FFRT) SETUP

FLOWCHART OF MODEL 700

SETTING ANALOG OUTPUT LEVELS (0-20/4-20 mA)

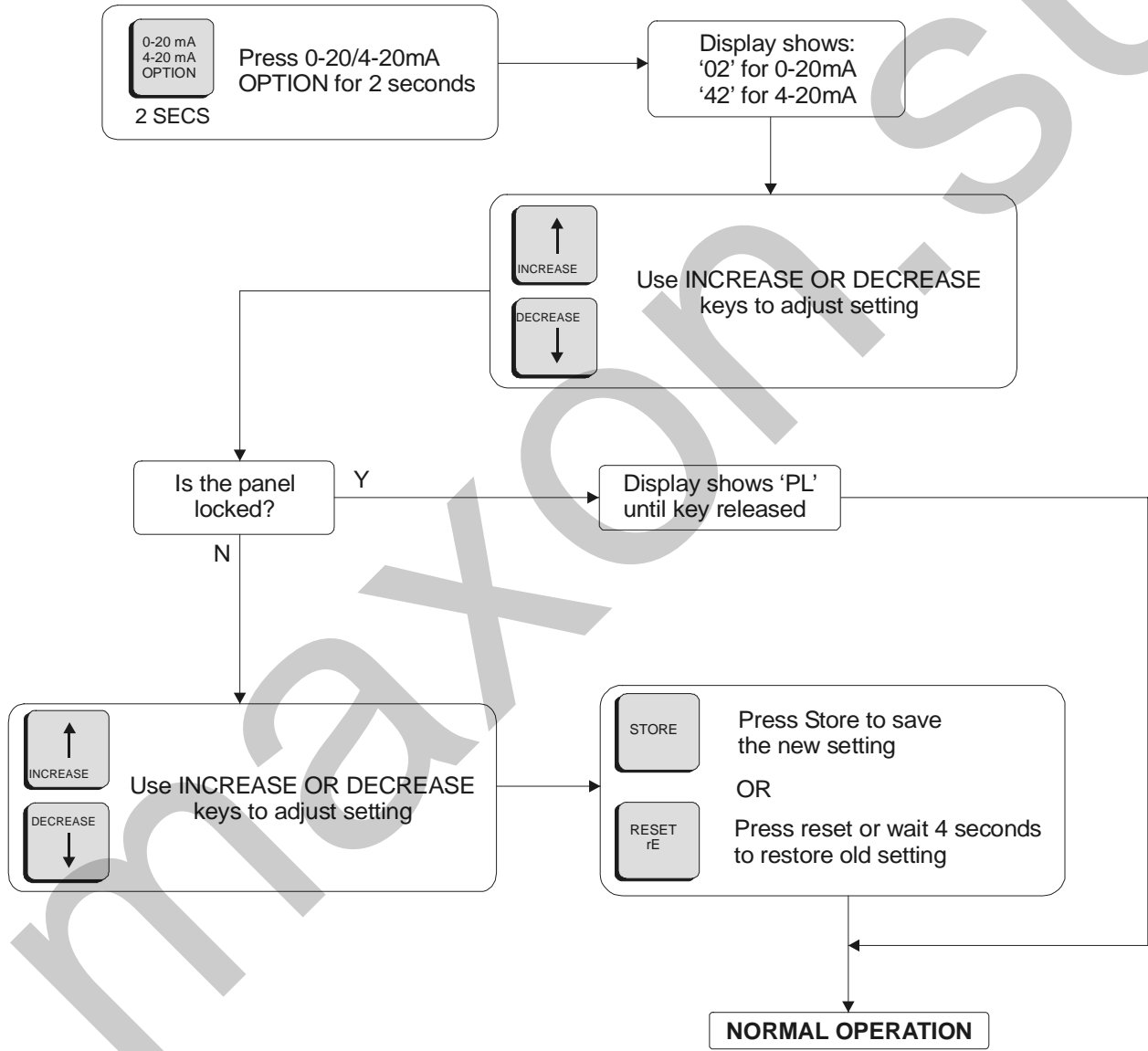

FLOW CHART 8 - 0-20/4-20mA ANALOG OUTPUT SETUP

FLOWCHART OF MODEL 700

SETTING VIEWING HEAD GAIN

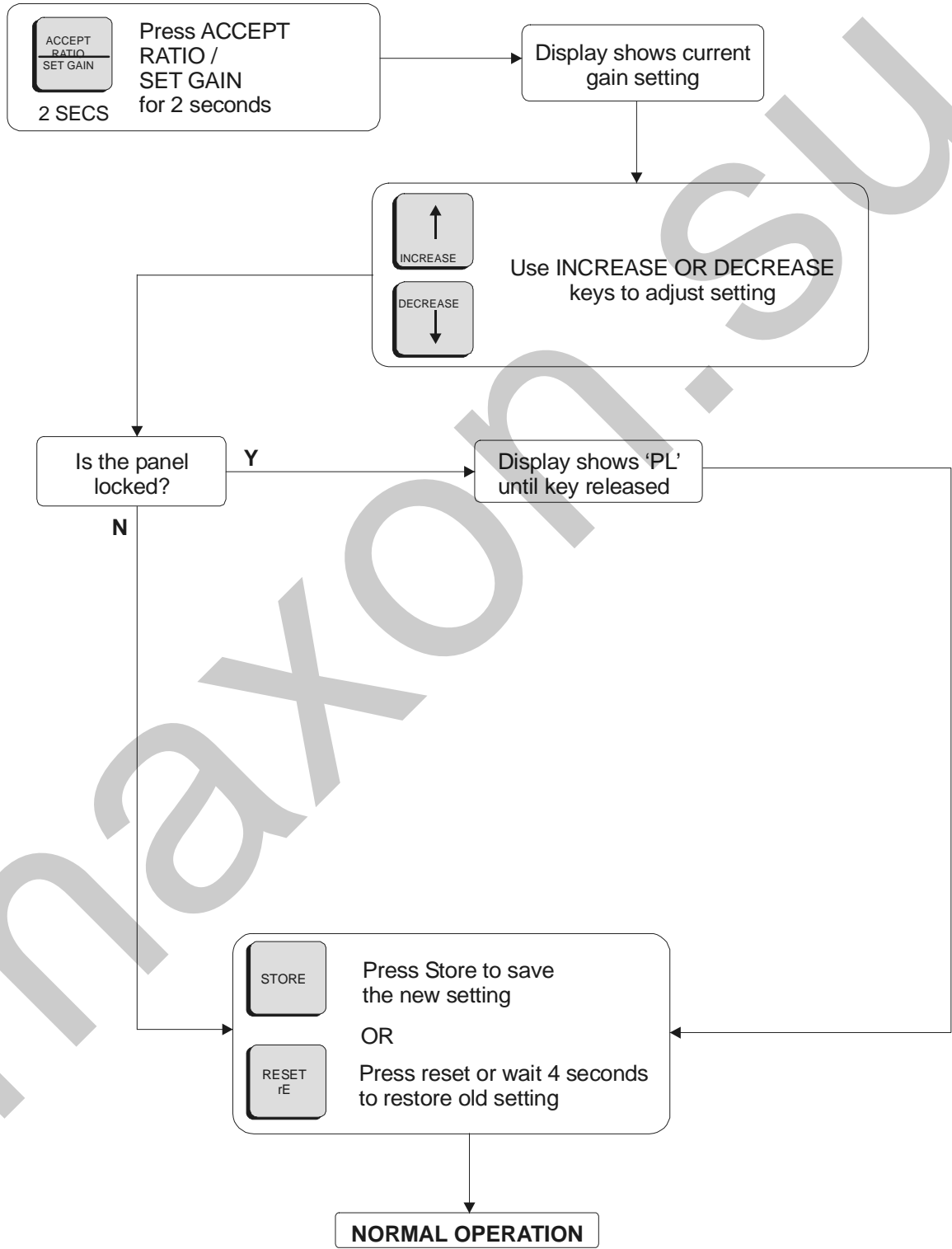

FLOW CHART 9 - VIEWING HEAD GAIN SETTING

SPECIFICATIONS FOR SERIES 700 AND 800 VIEWING HEADS

*MODELS S702, S702-PF, S702-HF, S702-HF-PF, S706, S706-PF,
AND MODELS S802, S802-HF, AND S806*

ELECTRICAL

- Input Power** - 22VDC to 26VDC, 150 mA MAX from Model 700AC, Model 700DC or Model 800 Signal Processor

ENVIRONMENTAL

- Viewing Head Sealing** - NEMA TYPE 4/4X rated when the molded connector ring is tightened with pliers and a UV protection is provided for the cable.
- Ambient Temperature** - -40°C to 85°C (-40°F to 185°F)

IR DETECTOR SPEC

**(S702, S702-PF, S702-HF,
S702-HF-PF, S802, S802-PF)**

- InGaAs (Indium Gallium Arsenide) photodiode with spectral response 950nm to 1710nm (1/2 intensity points)
- 33 Hz standard, 155 Hz High Freq. option (-HF)

High Pass Filter Pickup

IR OPTICAL

- Angle of View** - 1 degree (1.45" dia. at 6 ft.)

UV DETECTOR SPEC

(S706 & S706-PF, S806)

- UVtron with spectral response 185nm to 260nm

UV OPTICAL

- Angle of View** - 5 degrees (1 inch per foot)

CABLE & CONNECTOR

(Signal Proc. to V.H.)

- (Standard) C330, 4 Conductor, 18 AWG shielded, 90C, Sunlight Resistant, 15 ft. long, with ITC rating for US and CIC rating for Canada. (This rating permits use in hazardous locations without a conduit.)
- With PF option 4 conductor, 22 ga. or larger with overall braided shield, 95% coverage, or with shield over the signal line. Tie shield to ground at viewhead end and signal processor end of cable. (Cable must be protected by a conduit in hazardous locations.)

SPECIFICATIONS FOR MODEL 700AC & MODEL 700DC SIGNAL PROCESSORS

ELECTRICAL – MODEL 700AC

- Primary Input Power** - 85-265VAC, 50-60 HZ, 0.07A MAX. fused (with either V.H. connected)
- Battery Backup Voltage** - 22VDC to 26VDC, 0.2A DC MAX. fused (with either V.H. connected)

ELECTRICAL – MODEL 700DC

- Primary Input Power** - 22VDC to 26VDC, 250 mA MAX, fused (with either V.H. connected)
- Battery Backup Voltage** - 22VDC to Input Voltage -.5VDC, fused (with either V.H. connected)

OUTPUTS

- Flame Relay** - 2 form C contacts
- Self-Checking Relay** - 1 form C contact
- Relay Contact Ratings** - 5A at 125 VAC, 277 VAC, & 30 VDC; 1/8 HP 125 & 250 VAC
- Analog Flame Signal** - isolated 0 to 20 mA or 4 to 20 mA output for remote meters or DCS, 360 ohms maximum resistance

ENVIRONMENTAL

- Ambient Temperature** - 0°C to 50°C (32°F to 122°F)

MODEL 800 SIGNAL PROCESSOR SPECIFICATIONS

ELECTRICAL

- Primary Input Power** - 85-265VAC, 50-60 HZ, 0.10A MAX. fused (with either V.H. connected)

OUTPUTS

- Flame Relay** - 2 form A contacts
- Flame Relay Contact Ratings** - 5A at 125 VAC, 250 VAC, and 30 VDC
- Self-Checking Relay** - 1 form A contact
- Self-Check Relay**
- Contact Ratings** - 0.4A: 110 VDC, 125 VAC; 2A: 30VDC
- Analog Flame Signal** - 0 to 20 mA or 4 to 20 mA output for remote meters or DCS, non-isolated, 100 ohms maximum resistance

ENVIRONMENTAL

- Ambient Temperature** - 0°C to 60°C (32°F to 140°F)